

Bu kitaba sığmayan daha neler var!

eba
www.eba.gov.tr



Karekodu okut, bu kitapla
ilgili EBA içeriklerine ulaş!

Teknoloji Yolculuğumuz

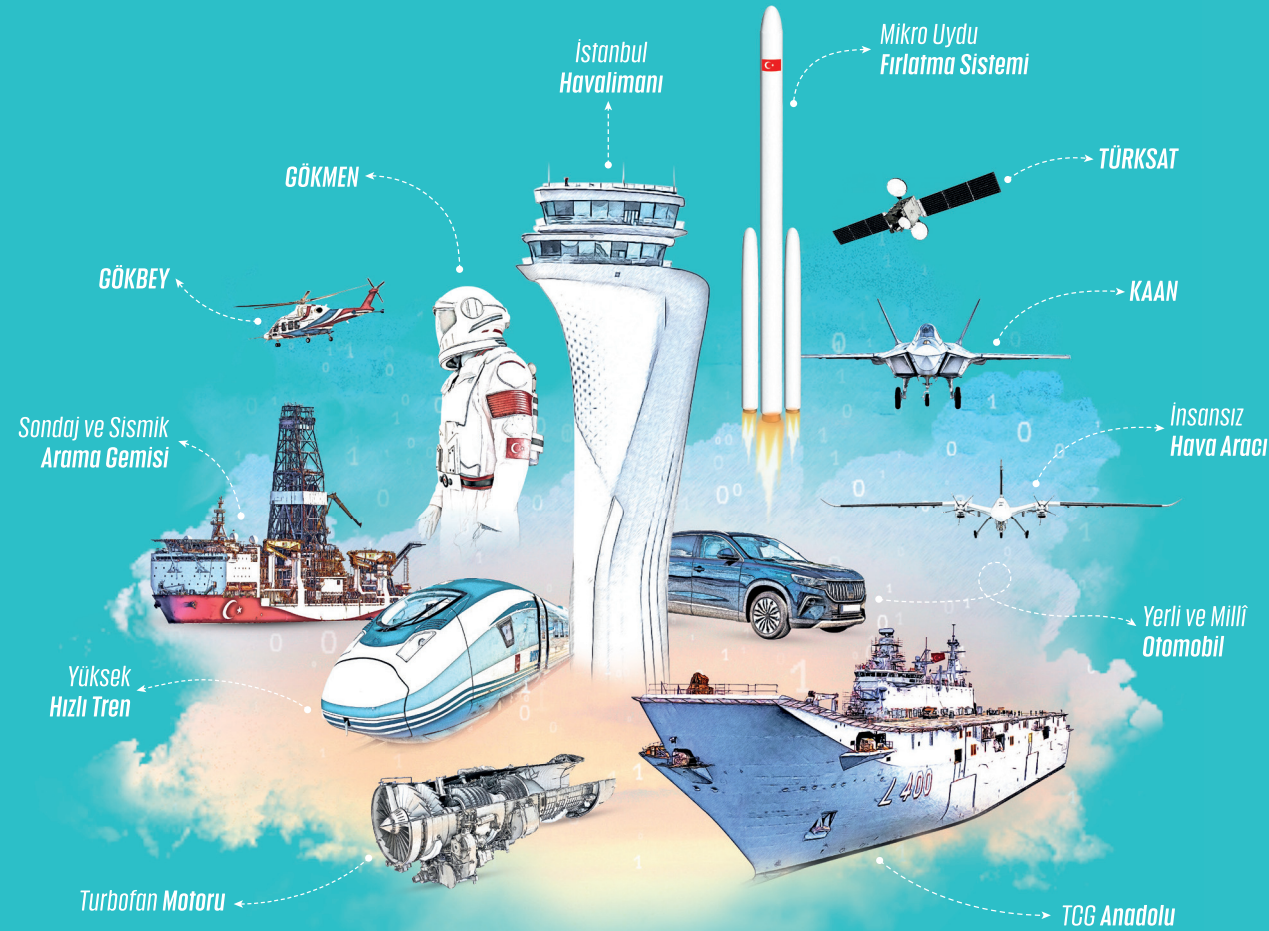

**BU DERS KİTABI MİLLÎ EĞİTİM BAKANLIĞINCA
ÜCRETSİZ OLARAK VERİLMİŞTİR.
PARA İLE SATILAMAZ.**

ISBN: 978-975-11-7132-0

Bandrol Uygulamasına İlişkin Usul ve Esaslar Hakkında Yönetmeliğin Beşinci Maddesinin İkinci Fıkrası Çerçevesinde Bandrol Taşınması Zorunlu Değildir.

DEPARTMENT OF INFORMATION TECHNOLOGIES

VOCATIONAL FOREIGN LANGUAGE

11-12

COURSE MATERIAL

VOCATIONAL AND TECHNICAL
ANATOLIAN HIGH SCHOOL

DEPARTMENT OF INFORMATION TECHNOLOGIES

11-12 COURSE
MATERIAL

VOCATIONAL FOREIGN LANGUAGE



VOCATIONAL AND TECHNICAL ANATOLIAN HIGH SCHOOL

DEPARTMENT OF INFORMATION TECHNOLOGIES

**VOCATIONAL FOREIGN
LANGUAGE
11-12
COURSE MATERIAL**

AUTHORS

Dr. Selçuk Yusuf ARSLAN

Çiğdem TUFAN TUĞCU

Hülya ÖZKAN



MİLLÎ EĞİTİM BAKANLIĞI YAYINLARI : 8348
YARDIMCI VE KAYNAK KİTAP DİZİSİ : 2240

Her hakkı saklıdır ve Millî Eğitim Bakanlığına aittir. Ders materyalinin metin, soru ve şekilleri kısmen de olsa hiç bir surette alınıp yayımlanamaz.

PREPARED BY

Language Specialist

Sema ÇAKMAK

Program Development Specialist

Dr. Eda ÖZ

Assessment and Evaluation Specialist

Hatice GÜRDİL EGE

Guidance Specialist

Fatih DÜĞENCİ

Graphic Designer

Ayşe KATIRCI KARBUKAN

Fırat DOĞAN

ISBN: 978-975-11-7132-0

Millî Eğitim Bakanlığının 24.12.2020 gün ve 18433886 sayılı oluru ve Meslekî ve Teknik Eğitim Genel Müdürlüğünce ders materyali olarak hazırlanmıştır.

BASKI

Ayrıntı Basım Yayım ve Mat. Hiz. Sanayi Ticaret A.Ş.
Saray Mahallesi 126. Cadde No: 20
Kahramankazan/Ankara
Sertifika No: 49599



İSTİKLÂL MARŞI

Korkma, sönmez bu şafaklarda yüzen al sancak;
Sönmeden yurdumun üstünde tüten en son ocak.
O benim milletimin yıldızıdır, parlayacak;
O benimdir, o benim milletimindir ancak.

Çatma, kurban olayım, çehreni ey nazlı hilâl!
Kahraman ırkıma bir gül! Ne bu şiddet, bu celâl!
Sana olmaz dökülen kanlarımız sonra helâl.
Hakkıdır Hakk'a tapan milletimin istiklâl.

Ben ezelden beridir hür yaşadım, hür yaşarım.
Hangi çılgın bana zincir vuracakmış? Şaşarım!
Kükremiş sel gibiyim, bendimi çiğner, aşarım.
Yırtarım dağları, enginlere sığmam, taşarım.

Garbın âfâkını sarmışsa çelik zırhlı duvar,
Benim iman dolu göğsüm gibi serhaddim var.
Ulusun, korkma! Nasıl böyle bir imanı boğar,
Medeniyet dediğin tek dişi kalmış canavar?

Arkadaş, yurduma alçakları uğratma sakın;
Siper et gövdeni, dursun bu hayâsızca akın.
Doğacaktır sana va'dettiği günler Hakk'ın;
Kim bilir, belki yarın, belki yarından da yakın.

Bastığın yerleri toprak diyerek geçme, tanı:
Düşün altındaki binlerce kefensiz yatanı.
Sen şehit oğlusun, incitme, yazıktır, atanı:
Verme, dünyaları alsan da bu cennet vatanı.

Kim bu cennet vatanın uğruna olmaz ki feda?
Şüheda fışkıracak toprağı sıksan, şüheda!
Cânı, cânânı, bütün varımı alsın da Huda,
Etmesin tek vatanımdan beni dünyada cüda.

Ruhumun senden İlähî, şudur ancak emeli:
Değmesin mabedimin göğsüne nâmâhrem eli.
Bu ezanlar -ki şehadetleri dinin temeli-
Ebedî yurdumun üstünde benim inlemeli.

O zaman vecd ile bin secde eder -varsa- taşım,
Her cerâhamdan İlähî, boşanıp kanlı yaşım,
Fışkırır ruh-ı mücerret gibi yerden na'sım;
O zaman yükselerek arşa değer belki başım.

Dalgalan sen de şafaklar gibi ey şanlı hilâl!
Olsun artık dökülen kanlarımın hepsi helâl.
Ebediyyen sana yok, ırkıma yok izmihlâl;
Hakkıdır hür yaşamış bayrağımın hürriyyet;
Hakkıdır Hakk'a tapan milletimin istiklâl!

Mehmet Âkif Ersoy

GENÇLİĞE HİTABE

Ey Türk gençliği! Birinci vazifen, Türk istiklâlini, Türk Cumhuriyetini, ilelebet muhafaza ve müdafaa etmektir.

Mevcudiyetinin ve istikbalinin yegâne temeli budur. Bu temel, senin en kıymetli hazinendir. İstikbalde dahi, seni bu hazineden mahrum etmek isteyecek dâhilî ve hâricî bedhahların olacaktır. Bir gün, istiklâl ve cumhuriyeti müdafaa mecburiyetine düşersen, vazifeye atılmak için, içinde bulunacağın vaziyetin imkân ve şeraitini düşünmeyeceksin! Bu imkân ve şerait, çok namüsaî bir mahiyette tezahür edebilir. İstiklâl ve cumhuriyetine kastedecek düşmanlar, bütün dünyada emsali görülmemiş bir galibiyetin mümessili olabilirler. Cebren ve hile ile aziz vatanın bütün kaleleri zapt edilmiş, bütün tersanelerine girilmiş, bütün orduları dağıtılmış ve memleketin her köşesi bilfiil işgal edilmiş olabilir. Bütün bu şeraitten daha elîm ve daha vahim olmak üzere, memleketin dâhilinde iktidara sahip olanlar gaflet ve dalâlet ve hattâ hıyanet içinde bulunabilirler. Hattâ bu iktidar sahipleri şahsî menfaatlerini, müstevlîlerin siyasî emelleriyle tevhit edebilirler. Millet, fakr u zaruret içinde harap ve bîtap düşmüş olabilir.

Ey Türk istikbalinin evlâdı! İşte, bu ahval ve şerait içinde dahi vazifen, Türk istiklâl ve cumhuriyetini kurtarmaktır. Muhtaç olduğun kudret, damarlarındaki asil kanda mevcuttur.

Mustafa Kemal Atatürk

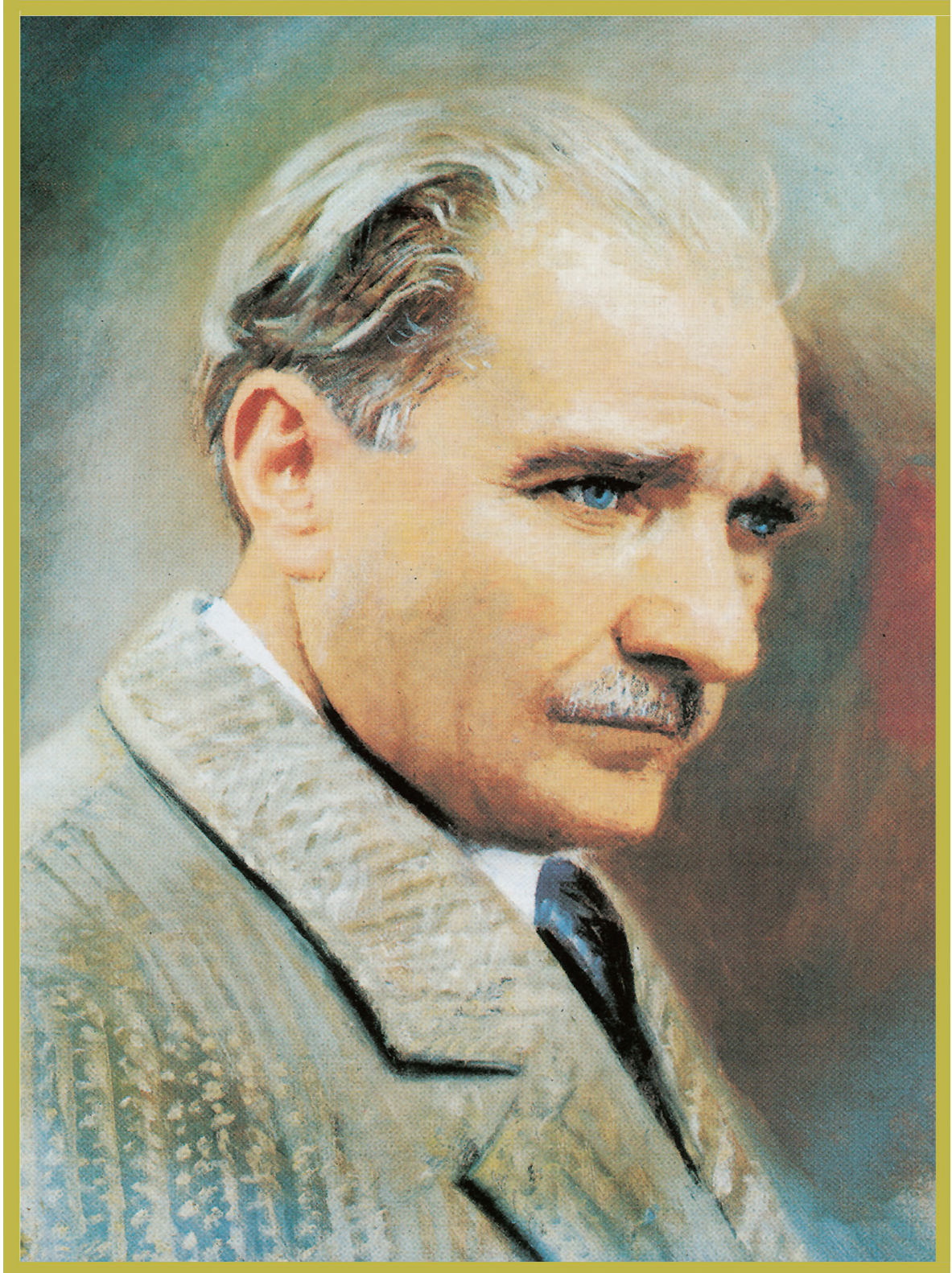

MUSTAFA KEMAL ATATÜRK

CONTENTS



INTRODUCTION OF COURSE MATERIAL	13
1. HARDWARE AND COMPUTER COMPONENTS ..	18
1.1. LIST OF HARDWARE	18
1.1.1. Mainboard	21
1.1.2. CPU(Central Processing Unit)	24
1.1.3. Memory	27
1.1.4. Graphics Card (Display Adapter)	30
1.1.5. Disks	32
1.1.5.1. HDD Harddisk	32
1.1.5.2. SSD Disks	32
1.1.6. Optical Drives	34
1.1.6.1. CD Drives	34
1.1.6.2. DVD Drives	34
1.1.6.3. BluRay Drives	34
1.2. COMPUTER COMPONENTS	36
1.2.1. Keyboard	36
1.2.2. Mouse	38
1.2.3. Monitor	41
1.2.3.1. Cathode Ray Tube (CRT) Monitor	41
1.2.3.2. Liquid Crystal Display (LCD)	41
1.2.3.3. Plasma Display	42
1.2.3.4. Led Display	42
1.2.4. Printers	44
1.2.4.1. Dot Matrix Printers	44
1.2.4.2. Ink Jet Printers	44
1.2.4.3. Laser Printers	44
1.2.4.4. LED Printers	44
1.2.4.5. 3D Printers	44
1.2.5. Scanners	47



2

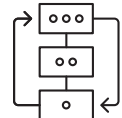
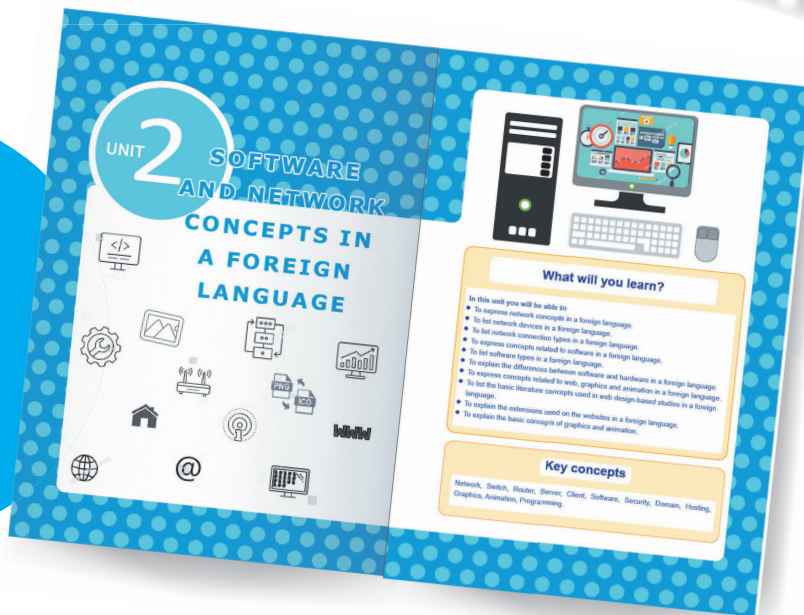

2. SOFTWARE AND NETWORK CONCEPTS	52
2.1. NETWORKS	52
2.1.1. Types of Networks	52
2.1.2. Network Connection Types	55
2.1.3. Types of Cables	55
2.1.4. Network Equipment	57
2.1.5. Network Devices	57
2.2. SOFTWARE	60
2.2.1. Software Types	61
2.3. WEB, GRAPHICS AND ANIMATION	64
2.3.1. Web Pages	64
2.3.1. Website Domain Extensions	68
2.3.2. Domain	69
2.3.3. Graphics and Animation	71
2.3.4. Basic Concepts of Graphics	74
2.3.5. Image Formats	77
2.1. BASIC PROGRAMMING CONCEPTS	79



3



3. PREPARING CV AND JOB APPLICATION 86

3.1. CV (CURRICULUM VITAE) 86

3.2. JOB APPLICATION 102

 3.2.1. CV Preparation and Cover Letter Writing..... **102**

 3.2.2. Job Applications..... **103**

 3.2.3. Interview (Job Interview) **106**

 3.2.4. Job offer **109**

ANSWER KEYS(IT'S YOUR TURN) 111

ANSWER KEYS(ASSESSMENT AND EVALUATION) 120

REFERENCES..... 121





INTRODUCTION OF COURSE MATERIAL

Learning unit number.

Learning unit name.



It shows what you will learn in the learning unit.

Keywords of the learning unit.



Title of the learning unit.

Unit name.

2. SOFTWARE AND NETWORK CONCEPTS

PRE-READING ACTIVITY

Share your thoughts on the questions given below with your classmates.

Pre-lesson activities.

1. What networks do you know around you?
2. What software do you use most often?
3. What web pages do you visit frequently?
4. What words do you know about web, graphics and animation?

2.3. NETWORKS

Connecting devices to each other for the purpose of sharing information is called a network. Networking is a technology that connects various devices for data sharing. The most widely known network is the Internet. The purpose of the network is data sharing. There are many types of networks. A network that connects computers directly to each other is called a peer-to-peer network. The networks used by devices in the same environment such as home, classroom or office are called local area network (LAN). The network which is created by connecting personal devices to each other is called the Personal Area Network (PAN). The largest network formed by interconnecting many networks is called a Wide Area Network (WAN). Networks that are created between many LANs in a city or large campus are called Metropolitan Area Network (MAN). Networks that are set up through remote access, and where security must be at a high level, such as banks, are called virtual private networks (VPNs).



Subject texts that support the learning outcomes.

2.3.6. TYPES OF NETWORKS

Peer-to-Peer Network, LAN (Local Area Network), WAN (Wide Area Network), PAN (Personal Area Network), MAN (Metropolitan Area Network), VPN (Virtual Private Network)

Studies that will enable students to use the information.

Name of the course

IT'S YOUR TURN 1

- A) Match the definitions (1-5) with the pictures (a-e).
7. (.....) Topology where all computers are connected via a single cable.
 8. (.....) Topology in which machines are connected end-to-end around the circle.
 9. (.....) Topology where machines are connected to each other by a switch or a hub.
 10. (.....) Topology in which all machines are connected to each other end-to-end.
 11. (.....) A circular or hexagonal topology with individual nodes at the center.



B) Write "T" for True statements and "F" for False statements at the beginning of the following sentences.

1. (.....) Secure networks used for remote access to computer networks are called VPNs.
2. (.....) Networks that connect computers in limited areas such as offices and schools are called wide area networks.
3. (.....) A network of personal devices is called PAN.
4. (.....) Networks created in a single unit such as laboratory, classroom, office are called Local Area Network.
5. (.....) Networks formed by connecting two computers to each other are called private virtual networks (VPN).

C) Fill in the blanks in the sentences given below with the appropriate words in the box.

Wan	Peer To Peer	Man	Vpn	Internet
-----	--------------	-----	-----	----------

1. The network in which two computers are connected to each other without central control is called
2. The computer networks used in a city or campus are called
3. The network formed by the interconnection of many local networks in a wide geographical area is called
4. The largest known network is called
5. A secure network technology that enables to establish a secure communication link between two different networks is called

D) Define the words given below with your own sentences.

1. Network:
2. Switch:

Page number



UNIT 3: PREPARING CV AND JOB APPLICATION IN A FOREIGN LANGUAGE

That's why creating an e-mail in a formal language can be a good step. Generally, emails consist of 4 parts: Subject, Greeting, Text, Closing.

Subject: Write the reason for sending the e-mail briefly here. It is a common mistake to write the text of the email in this section and leave the text field blank. For example, you should write a short subject that describes your email, such as Requesting a meeting.

Greeting: In this section, you address the person you are sending the email. For example, you can start as Dear Director Ayyıldız, Dear Professor Arslan. If you're writing to a group, start with something like Dear Sales Team. If you have no idea about the person or group you are addressing, Dear Sir/Madam, which gives the meaning to the person concerned, is a good option.

Note: The phrase To Whom It May Concern also shows the person concerned. It is generally used in reference letters.

Text: It is the area where you will express yourself in your e-mail. It is recommended not to be too long. When the email consists of 2 paragraphs of 3-4 sentences, it can be read easily without being distracted by the recruiter. Make a maximum of 1-2 requests in this section. Avoid complaining about an issue.

Closing: This is the section where you end your email and convey your best wishes to the email recipient. You can end your email with a phrase like best regards. Just below, you can write your name and surname, your job if you wish and complete the e-mail.

Before sending your email, read it again from the beginning and send it!

An example email:

Dear Mrs. Richards,

I hope you are fine. I focused on web development during my senior high school internship and I am interested in your job position. I am writing you this email for the web developer position on your company's website. I would like to receive information from you about the requirements for this position. Thank you in advance for your reply.

Kind regards,
Zeynep Buse Aydemir

100

Notes about the subject

UNIT 3: PREPARING CV AND JOB APPLICATION IN A FOREIGN LANGUAGE

ASSESSMENT AND EVALUATION 3

Answer the following questions.

- Which of the following skills are hard skills?
A) Collaboration B) Communication C) Leadership
D) Machine learning E) Time management
- Which of the following is one of the optional parts in CVs?
B) Contact information B) Education information
C) Hobbies D) Skills and achievements
E) Work history
- Which one is wrong for CVs?
A) CVs are documents that are not updated.
B) CVs must be specific to the application.
C) Skills and experiences should be highlighted in CVs.
D) CVs must contain contact information.
E) CVs may have different structures.
- Which of the following is not one of the email sections?
A) Closing B) Cover letter C) Greeting D) Subject E) Text
- What is the software developed for the solution of a problem that users install according to their needs?
A) You should introduce yourself by greeting the interviewer.
B) Be a good listener and not interrupt the other person.
C) You should give short and clear answers to the questions.
D) You must be sincere and make the other one feel it.
E) You should write down your questions on your mobile phone during the interview.
- Which one you don't need to do in the pre-interview preparation?
A) Getting information by contacting the people working in that institution
B) Researching the institution you are applying to
C) Checking that your CV is up-to-date
D) Researching and preparing for possible questions
E) Reviewing the job description

106

Assessment and evaluation section.



UNIT **1**

**HARDWARE
CONCEPTS IN
A FOREIGN
LANGUAGE**

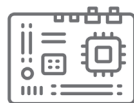
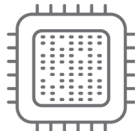
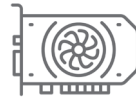
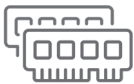

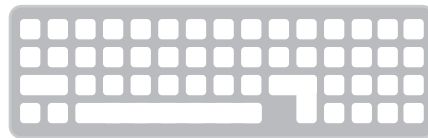
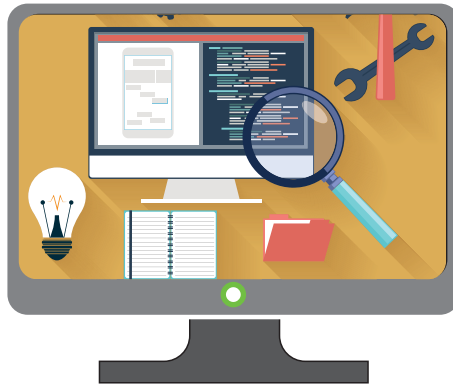
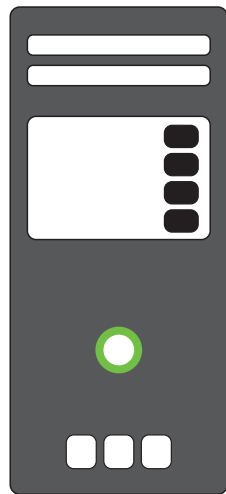

What will you learn?

In this unit you will be able to

- to explain the hardware concept in a foreign language,
- to describe computer components in a foreign language,
- frequently used terms in information technologies literature.

Key Concepts

Computer Science, Information Technology (IT), Hardware, Bug, Cache, Memory, Default, Input Device, Output Device, Memory, Peripheral, Storage, Equipment, Software, Audio, Mainboard, Bandwidth, Data Bus, Power Supply, Power Cable, Graphic Interface, Central Processing Unit, Data Processing, Service, Cloud Based System.

1. HARDWARE AND COMPUTER COMPONENTS

PRE-READING ACTIVITY

Share your thoughts on the questions given below with your classmates.

1. What computer component names do you know in English?

Read the following text aloud and translate it into Turkish.

Information-based technologies that enable the practical processing of information, and its transformation into useful service forms for people are called information technologies.

There are four elements that make up information technologies; software, services, equipment and hardware. Various software tools working with cloud-based systems and information tools enable specified aims to take place as expected from information technologies. With these tools, it is aimed to collect, process and analyze data, and design a new product or service a model as a result of these analyzes.

All the electronic parts of the computer that we can physically touch and see are called computer hardware. It refers to the parts which are essential to building a computer. Computer hardware is independent from the operating system. There is also a need for an operating system to use computer hardware effectively. There are many hardware types that make up the computer. Some of them are compulsory components required for basic functions such as the operation of the computer and the loading of the operating system. And some components are optional and used when they are needed.

1.1. LIST OF HARDWARE

- Computer case
- Mainboard (Motherboard)
- Power cable
- CD-ROM (Compact Disc Read-Only Memory)
- Sound card
- CPU fan
- CPU (Central Processing Unit)
- Graphics card
- RAM (Random Access Memory)
- Hard disk
- DVD (Digital Video Disc)

IT'S YOUR TURN 1

A) Match the following pictures with the appropriate words.



1. (.....) Power Supply
2. (.....) Computer Case
3. (.....) Power Cable
4. (.....) CPU(Central Processing Unit)

B) Write "T" for True statements and "F" for False statements at the beginning of the following sentences.

1. (.....) A hard disc stores vast amounts of data.
2. (.....) Hardware includes computer programs which are also called applications or apps.
3. (.....) RAM stores information temporarily.
4. (.....) Mainboard makes arithmetic and logical processing.

C) Fill in the blanks in the sentences below with the appropriate words in the box.

Hardware	Information Technology	Power Cable
Computer Case	CPU(Central Processing Unit)	

1. consists of four elements: software, services, equipment and hardware.
2. The physical and mechanical components of a computer system, such as the electronic circuitry, chips, monitor, disks, disk drives, keyboard, routers and printer are generally called
3. Box which contains all the physical parts of the computer is called
4. is the equipment that supplies electricity to the computer.
5. is the brain of the computer which is also called processor is the brain of the computer.

D) Define the words given below with your own sentences.

1. Power cable:
2. Power supply:

E) PUZZLE

All the words to be filled are in the network topic.

Across

1. It is the internal hardware unit which is used to run the components that make up the computer and distribute the necessary energy.
2. It is the cable which is used to transmit electric current.
3. It is the name which is given to all the programs that enable the computer to do a specific task.
4. It is the electronic circuit that connects all parts and peripherals of your computer and provides communication between these units.
5. It is an electronic recording device for recording data permanently.
6. It is the general name of the physical parts that make up the computer.

Down

1. It is a memory element where various programs are run on a computer or any electronic device, and temporary or permanent information will be found.
2. It is the element that protects components to be placed inside a computer against physical impacts that may come from the outside.
3. It is a type of data storage or memory unit that allows the stored information to be accessed quickly.
4. It is the element that performs analog and digital audio operations on the computer.

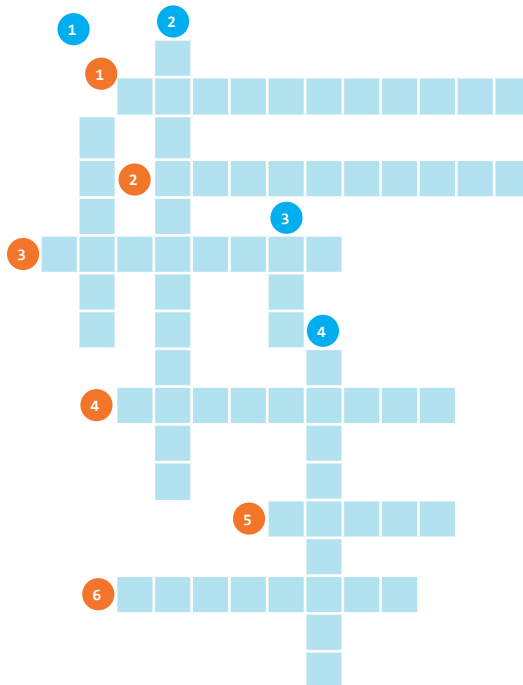

1.1.1. Mainboard

Read the following text aloud and translate it into Turkish.

Mainboard is an electronic card which provides data transmission between all internal and external parts of the computer. It is affected badly by sudden electrical changes. Therefore, when working on it, it should be isolated from static electricity. The features of the hardware cards to be added to the mainboard should be determined according to the mainboard user manual. Every hardware unit doesn't work with every motherboard.

The main task of the mainboard is to host the computer processor (CPU) and to enable all other hardware units to communicate with the processor. It sends the list of hardware units installed on the mainboard to the operating system.

Northbridge and southbridge are chips on the motherboard. Northbridge is directly connected to CPU. Southbridge is connected to PCI bus slots, BIOS, SATA and IDE connectors and USB ports. If it is required for the CPU to communicate with AGP or PCI express slots etc., the communication occurs via the northbridge.

There are processor sockets, RAM slots, hard disk connection sockets, buses, BIOS on the mainboard. BIOS is software written on read-only memory (ROM). Expansion slots on the mainboard are used to add external hardware cards to the mainboard.

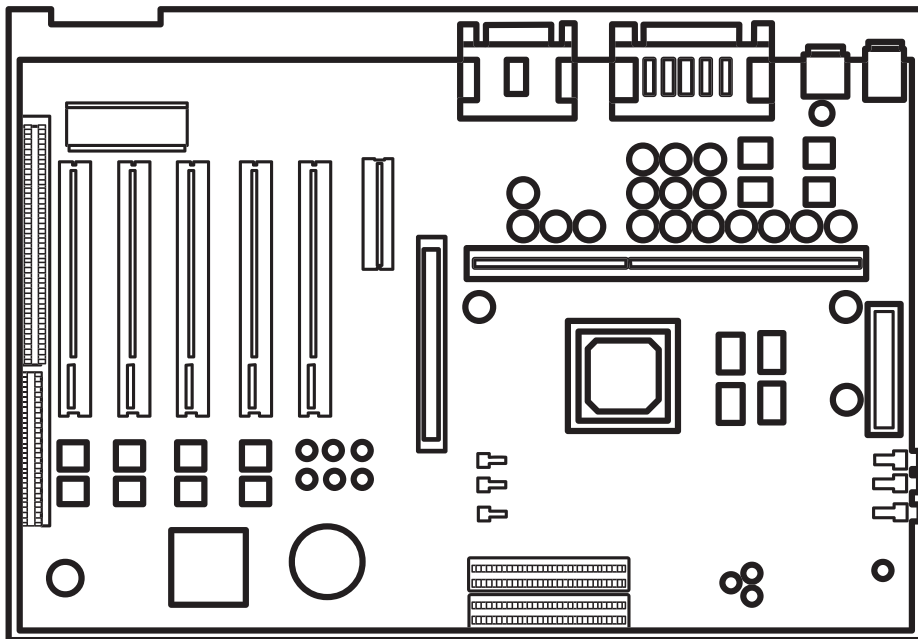

IT'S YOUR TURN 2

A) Match the numbers in the image below with the appropriate expressions in the box.

- | | | |
|--------------------------------------|------------------------------------|---------------------|
| CMOS Backup Battery | CPU Socket | ATX Power Connector |
| Connectors for Integrated Peripheral | CPU Fan & Heatsink Mounting Points | |

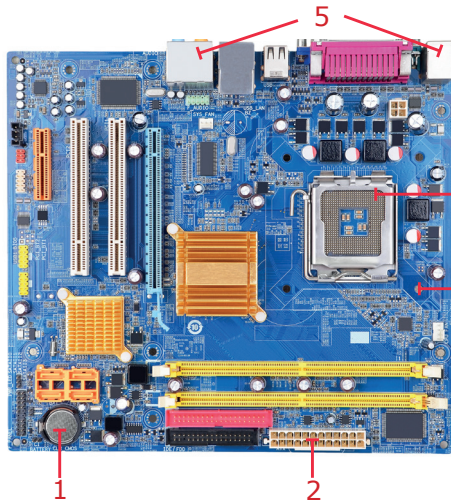

1.
2.
3.
4.
5.

Note: You can look at BTT (Fundamentals of Information Technologies 9) Book for Image

B) Write T for True statements and F for False statements at the beginning of the following sentences.

1. (.....) BIOS is a built-in software that exists in a small memory chip on the computer mainboard.
2. (.....) BIOS provides communication between hardware and processor.
3. (.....) AGP or PCIe expansion slots are used to add display cards on mainboards.
4. (.....) The shape and layout of the mainboard is the form factor.

C) Fill in the blanks in the sentences below with the appropriate words in the box.

- | | | | | |
|-----------|----------|----------|----------|-----------------|
| Interface | Bandwith | Data bus | Capacity | Connecting Slot |
|-----------|----------|----------|----------|-----------------|

1. is the path that enables to communicate hardware and ports on the mainboard.
2. The AGP bus is found on the mainboards as where the graphics cards will be installed.
3. of BIOS is accessed by holding down DEL or ESC or F2 keys.
4. ISA port with low is not used in today's mainboards.
5. Memory type and are variable for each motherboard.

D) Explain the words given below in your own words.

1. Bandwith:
2. North Bridge:

E) PUZZLE

All the words to be filled are in the network topic.

Across

1. It is the basic unit that controls and transfers data of these units, which are responsible for the processor, memory and AGP bus.
2. It is a data bus developed to control hard drives.
3. It is the unit responsible for input-output units, power management, PCI bus, and all features integrated into the motherboard with USB.
4. It is a bus that is only for video cards, allowing the graphics card to access the processor directly.
5. It is the unit that performs all image operations and calculations of images on the graphics card without reflecting it to the processor.

Down

1. It is the memory chip located on the motherboard of the computer.
2. It is the data capacity transmitted from one point to another per second over a computer network or internet connection.
3. It is a software that helps systems to boot by taking control of input and output devices.
4. They are circuits which are used to transmit data from one component of the computer to another.
5. It is an improved bus for connecting peripheral components with plug-and-play support.

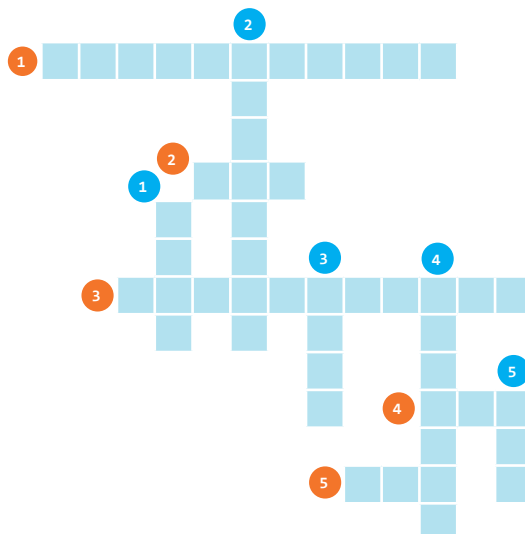

1.1.2. CPU(Central Processing Unit)

Read the following text aloud and translate it into Turkish.

The Central Processing Unit (CPU) ensures the operation of the operating system and other programs on the computers. They control the data between the hardwares. Processors perform the arithmetic and logical commands given to them. Their operating speeds vary according to the production their technologies and architectures. The speed units of the processors are HZ, MHZ and GHZ. Processors work with a machine language (low level coding consisting of 0 and 1). CPU can be considered as the brain of the computer. A computer cannot be run without a CPU.

The performance of the computer affects the performance of the CPU. Since the CPU is a fast-running hardware, it needs cooling systems. For this reason, thermal paste and heatsink are mouted to the CPU. There are 5 components in the structure of the computer processor:

Control Unit: It can be seen as the brain of the CPU itself. It controls all the operations of the computer. It provides control of input and output units, memory related operations, interpretation of commands and operation of the computer as a whole. The data received by the external hardware units of the computer is sent to the memory and from there to the Control Unit of the CPU. The data, which is processed in this section, turns into information.

Data Transmission Bus (Bus): They are the conductors that provide the connection between the processor and other hardware units of the computer. There are three different data transmission buses:

- **Address Bus:** All units and devices in the computer have an address. The processor reaches these devices via this address.
- **Data Bus:** Data flows between the processor and hardware devices via this bus.
- **Control Bus:** It is the bus the signals sent and used by the processor to manage other units and provide synchronization.

Counters: By carrying the addresses of the commands and data which are sent to the processor, they determine which data will be used in which order during the operation of the computer.

Cache: Data from system memory often cannot keep up with the speed of the CPU. For this reason, there is a need for high-speed memories to hold the data temporarily from the system memory in the CPU. These are called caches and they are divided into three levels, L1, L2, L3.

Arithmetic Logic Unit: It is the part where all the mathematical and logical operations are performed by the processor to be done. It is the most important part of the processor.

IT'S YOUR TURN 3

A) Match the pictures below with the appropriate words.

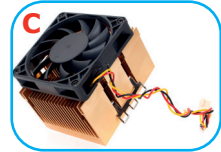
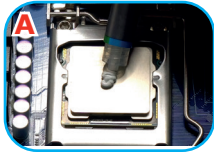

1. (.....) Heat Sink
2. (.....) Thermal Paste
3. (.....) Data bus
4. (.....) Machine Language

B) Write T for True statements and F for False statements at the beginning of the following sentences.

1. (.....) Machine Language consists of 1 and 0 number system.
2. (.....) Data Bus is used in the data flow between the processor and hardware units.
3. (.....) Address Bus is the path the signals sent and used by the processor to manage other units.
4. (.....) The processor is the backbone of the computer.
5. (.....) The high-speed memory in the CPU is called cache.

C) Fill in the blanks in the sentences below with the appropriate words in the box.

Machine Language	Brain Of Computer	Thermal Paste
Arithmetic Logic Unit		Heat Pipe Cooling

1. The processor is called since it is the part where logical and arithmetic operations are performed.
2. All mathematical and logical operations to be performed by the processor are performed by
3. is a material that can exchange heat and provides a perfect union between the processor and the heat sink.
4. Using the technique, the heat of the processor is transferred to the heat pipes, which are a special liquid inside, through the heat sink.
5. The coding system whose processors work with a low-level coding system formed by 1 and 0 is called

D) Explain the words given below in your own words.

1. Data bus:
2. Arithmetic logic unit:

E) PUZZLE

All the words to be filled are in the network topic.

Across

1. It is the unit that provides the execution of operations by interpreting all commands with electrical signals.
2. It is the lowest level programming language that allows the processor consisting of 1s and 0s to be operated in accordance with the given instructions, which varies according to the processor architecture.
3. It is the hardware unit that provides the operation of the computer's operating system and other programs, and processes data by controlling the data flow between the units.
4. It is the bus that carries the addresses generated by the processor to the computer's memory.
5. It is the material that can exchange heat and provides the union between the processor and the cooler.

Down

1. It is a high-speed memory which is located in the processor.
2. They are the hardware which are used to enter data into computers.
3. It is the unit that manages the processors and is defined as the brain of the computer.
4. It is the hardware that transforms the information created on the computer into a form that can be perceived by humans.
5. It is the expression which is used to specify the maximum number of operations that the processor can perform per second.

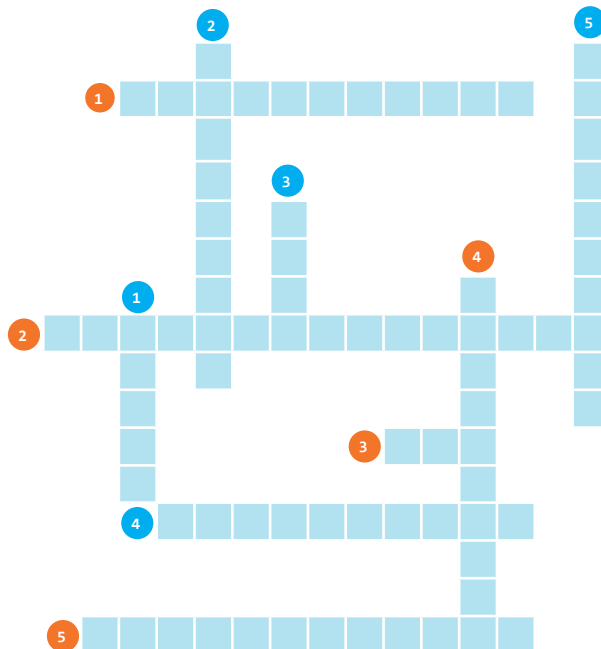

1.1.3. Memory

Read the following text aloud and translate it into Turkish.

Memory is a device capable of storing information in computers. Most electronic devices use some forms of memory. Phones, tablets, game consoles, scales, and even blood pressure monitors have memory.

Each device on the computer runs at different speeds. Computer memory allows the computer to access data quickly.

In computer science, information is sometimes stored permanently, sometimes temporarily. The processor of the computer obtains the information it wants to access from the main storage device; the hard disk. Getting information from hard disks negatively affects computer speed. For this reason, it has emerged that information needs to be transferred to the processor from another place with a higher speed. This section is called "volatile memory" and the processor can access information on the mainboard.

Memory is mounted directly into the memory slots on the mainboard. The type of memory which is compatible with the memory slots on the mainboard and the operating frequency which is supported by the mainboard should be selected.

There are two types of memory. Static RAM works very fast and it is expensive. It is generally used in the caches of processors. SRAM is faster than DRAM. Dynamic RAM, is the type of RAM which is used in the main memory of the system. DRAM is inexpensive.

- **ROM (Read only memory)** isn't volatile. ROM is used to store crucial information of operating system. It's always retains data. It has various types .
- **PROM (Programmable read-only memory)**: It can be programmed by the user. When it is programmed it can't be changed again
- **EPROM (Erasable Programmable read only memory)**: It can be reprogrammed. It is erased by ultraviolet light.
- **EEPROM (Electrically erasable programmable read only memory)**: The data can be erased by applying an electric field.

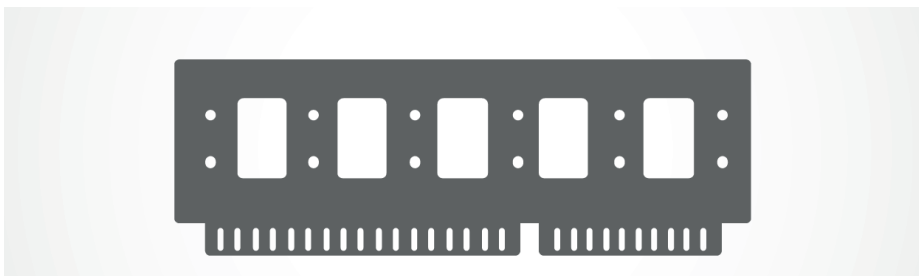

IT'S YOUR TURN 4

A) Match the numbers in the image below with the appropriate expressions in the box.

Socket	Notches for Socket(Handles)	Memory chip	Edge connector
--------	-----------------------------	-------------	----------------

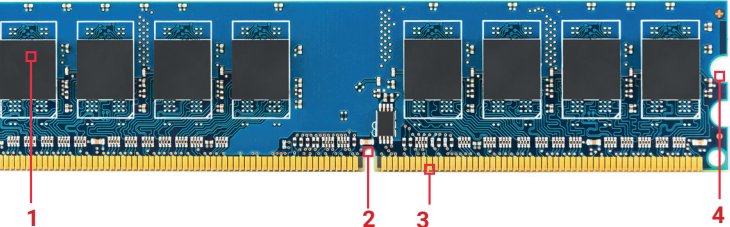

1.

2.

3.

4.

Note: You can look at BTT (Fundamentals of Information Technologies 9) Book for Image

B) Write T for True statements and F for False statements at the beginning of the following sentences.

1. (.....) RAM ,which is programmed by the manufacturer during the production, is just a readable type of memory.
2. (.....) RAM keeps the data received from the hard disks since computer is switch on and sends it to the processor.
3. (.....) It is necessary to select the type of RAM which is supported by the mainboard.
4. (.....) The selected ROM speed must be within the data transfer rate limits of the mainboard.
5. (.....) The unit of data storage capacity of RAM memories is GB.

C) Fill in the blanks in the sentences below with the appropriate words in the box.

Mounted	Frequency	Computer Science	Temporary Storage	Switched off
---------	-----------	------------------	-------------------	--------------

1. Memory is a kind of space used within a computer, such as RAM.
2. In information is sometimes stored permanently, sometimes temporarily.
3. It should be selected a memory compatible with and slot type supported by the mainboard.
4. Contents of memory are erased when the computer is
5. Memory is directly into the memory slots on the motherboard.

D) Explain the words given below in your own words.

1. Storage device:
2. RAM:

E) PUZZLE

All the words to be filled are in the network topic.

Across

1. They are the storage units that transmit the information and commands requested by the processor at maximum speed and keep the information on it temporarily or permanently.
2. It is the process of checking whether the basic components (Power supply, Processor, RAM, Video Card, Keyboard, etc.) are working at the first boot of the computer when the computer is turned on.
3. It is the part of the memory prepared to be plugged into the socket on the motherboard.
4. It is a static random access memory.
5. It is a dynamic random access memory.

Down

1. It is a type of ROM that can be reprogrammed after being erased under ultraviolet light.
2. It is a type of ROM that can be electrically erased and reprogrammed.
3. It is the unit with a locked mechanism to fix the processor in which the processor is installed.
4. It is a type of ROM that can be taken as blank and programmed once with a special circuit board.
5. It is the unit of measurement which is used to measure the capacity of the memory.

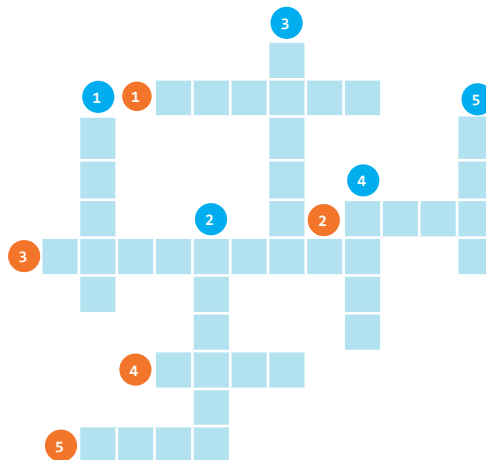

1.1.4. Graphics Card (Display Adapter)

Read the following text aloud and translate it into Turkish.

Graphics cards perform complex operations to create images. It sends the created image to the monitor. Graphics cards reduce the processing load on the CPU with a series of operations. Image-related operations are the most complex operations performed by the computer.

Graphics Processor (GPU): It is similar to the computer processor. GPUs are processors that execute graphics processing. It performs image calculations and image operations without putting a load on the computer's microprocessor. GPUs are integrated on graphics cards. The faster the GPU of a video card is, the faster graphics are produced. GPU processes images and videos at maximum speed and high resolution. GPUs can calculate parallel operations on a large dataset in milliseconds. As a result of this calculation, they can create 3d graphics.

Video RAM: It Is the memory which is used to hold the data related to the image while rendering the image. Its working principle is similar to system memory. It holds the information that the graphics processor sends to it. Its capacity directly affects the performance and image quality of the computer. Video RAMs store each pixel's color and on-screen location information and processed images until it's time to display them, so their speed and capacity are as high as system memories (RAM).

RAMDAC (Digital-Analog Converter): GPU processes the processed data as digital signals. Signals need to be sent to the analog monitor in analog form. RAMDAC performs the conversion of digital signals to analog signals. Video RAM is directly connected to the digital-to-analog (RAMDAC) converter. With DVI and HDMI technologies, RAMDAC has lost its importance. Transition-minimized differential signaling (TMDS) is now used to prevent electromagnetic interference during signal transmission in DVI and HDMI cables.

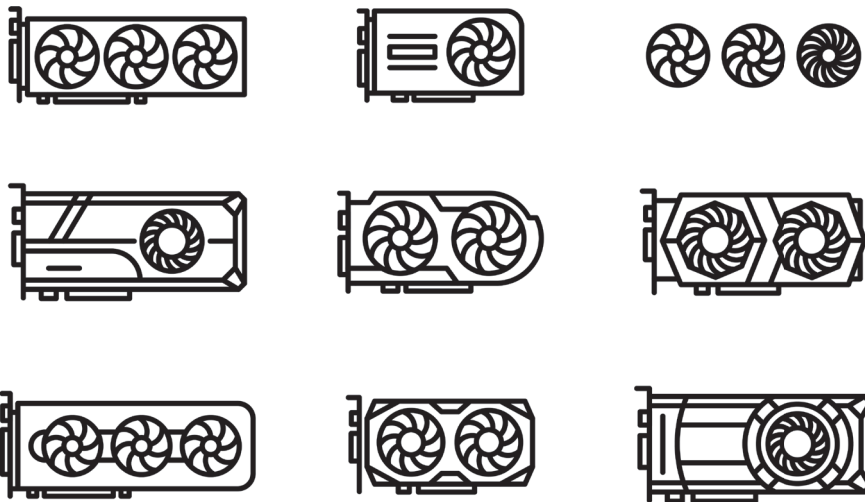

IT'S YOUR TURN 5

A) Match the numbers in the image below with the appropriate expressions in the box.

Graphics Card	Digital to Analogue Converter	Monitor
Analogue Signal	Digital Signal	

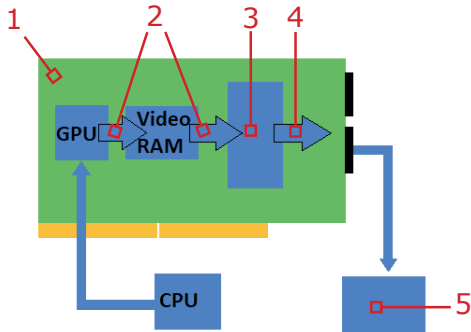

1.
2.
3.
4.
5.

Note: You can look at BTT (Fundamentals of Information Technologies 9) Book for Image

B) Write T for True statements and F for False statements at the beginning of the following sentences.

1. (.....) There is a processor and RAM memory on the graphics cards.
2. (.....) Signals from the graphics cards should be sent to the monitor digitally.
3. (.....) Data processed by GPU are analog signals.
4. (.....) The speed and capacity of video RAMs are as high as system memories (RAM).
5. (.....) GPU stores the color and position of each pixel.

C) Fill in the blanks in the sentences below with the appropriate words in the box.

Slot Clips	Pull	Screwdriver	Unplug	Image
------------	------	-------------	--------	-------

1. A graphics card is a hardware installed in computers to process
2. The latches close by pressing the graphics card against the

If you want to change old card with new graphics card :

3. You can use to remove the screw the old card to the case.
4. You can any cables connected to the old graphics card.
5. You can the old card out of the slot.

D) Explain the words given below in your own words.

1. Screw:
2. Monitor:

1.1.5. Disks

Read the following text aloud and translate it into Turkish.

Anything that stores data is called a disk. Disk technology is divided into two main groups: flash disk (removable disk) and hard disk (hard drive). Hard disks can be used externally or internally. There are 3 types of hard disks in today's technology; HDD, SSD and HD.

1.1.5.1. HDD Harddisk

Hard disks are places where our data is permanently stored within the computer. HDD stands for Hard Disk Driver, it is generally called as hard disk. Serious data loss may occur in case of HDD failure. It contains electrical, electronic and mechanical components in its structure. Its structure consists of mechanical parts. So it is the type of disk that is most likely to recover data.

Hard disks consist of the following components; a disk case on the outside, one or more plates(platter) where information is stored magnetically, read-write heads that write data to the plates, motors that move the plates and read-write heads, and a control card that holds the circuits which are responsible for controlling the disk. The data is written on a high density aluminum plates.

The rotation of the motor in the center of the hard disk directly affects the performance of the hard disk. The number of revolutions per minute of the magnetic plates is expressed in RPM (rotate per minute). It can be said that the higher the RPM value is, the higher the performance of the hard disk is.

Information is stored on plates as sectors and tracks. A track is a structure made up of concentric circles that make a complete revolution to store data. The number of tracks is directly proportional to the capacity of the disk drive. Each track is divided into small units are called sectors. The sizes of the sectors may vary depending on the file system which are used by the operating system. A cluster is formed by the getting together of the sectors. Data is stored in these clusters.

The computer must have a hard disk. Because the operating system is installed on the HDD.

1.1.5.2. SSD Disks

SSD uses a type of memory unit called "flash memory". In this case, it has a structure similar to RAM. Unlike RAM, it keeps the data permanently even when the power goes out.

SSDs are stored in flash chips. These chips provide long-term storage and protection of stored data, and enable users the opportunity to store their data securely. By this means, they can be used instead of hard disks.

Hard disks (HDD) have mechanical parts that store data on spinning disks. On the contrary, SSDs do not have moving parts. Therefore, it is more difficult for them to break down as a result of falling down than HDDs. SSDs, on the other hand, have no moving parts. It is said that SSDs are a kind of expensive USB stick.

They enable the SSD operating system to run faster, applications to load quickly, and data transfer to be done quickly and easily.

IT'S YOUR TURN 6

A) Match the numbers in the image below with the appropriate expressions in the box.

Actuator	Spindle (Disk Driving Engine)	Platter
HDD Case		Actuator Arm

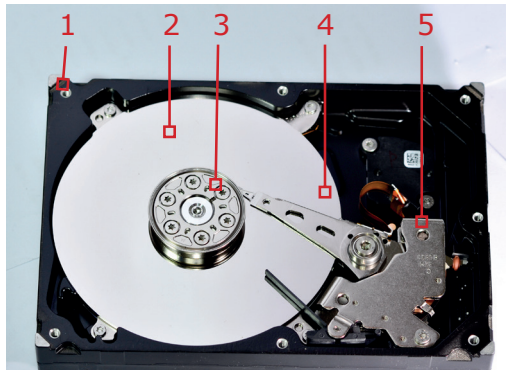

- 1.
- 2.
- 3.
- 4.
- 5.

B) Write T for True statements and F for False statements at the beginning of the following sentences.

- 1. (.....) Hard disk drives are types of temporary memory (volatile memory) such as RAM memories.
- 2. (.....) A cluster consists of sectors.
- 3. (.....) Hard drives store data temporarily.
- 4. (.....) Hard disks consist of mechanical parts.
- 5. (.....) The number of tracks is directly proportional to the capacity of the disk drive.

C) Fill in the blanks in the sentences below with the appropriate words in the box.

RPM (Rotate Per Minute)	Rotation speed of motor
Performance of hard disk drive	Plates Read-write head

- 1. The number of revolutions per minute of the magnetic plates is called
- 2. The on SATA hard disk drives are used for storage.
- 3. The RPM value is directly proportional to
- 4. in the hard disk directly affects the performance of the hard disk
- 5. Data is written to the plates with a

D) Explain the words given below in your own words.

- 1. RPM (rotate per minute):
- 2. HDD:

1.1.6. Optical Drives

Read the following text aloud and translate it into Turkish.

They are optical storage units where data is read and written with a special light system. Devices called optical drives are used to read data from optical storage units or write data from these units (media). There are three basic types of optical discs. These are;

1.1.6.1. CD Drives

CD drives can only read data written on a CD disc. Since the CD disc can only be read, it is called a CD-ROM. In CD-ROM drives, the reading process is done with a laser beam. CD drives that can write data on a CD disc are called CD-Writers. In CD-RWs, a separate laser beam is used for reading and writing.

CD-ROMs are discs made of aluminum, covered with a transparent polycarbonate material and coated with a protective varnish. CDs are single layered. Data can be written on only one surface. The information storage capacity of a CD is about 650-750 MB.

The disks on which data is recorded during production is called CD, the disk that can be produced as an empty and written on it once is called CD-R, the disks that are suitable for repeatedly writing data are called CD-RWs.

1.1.6.2. DVD Drives

DVD drives have faster read and write speeds than CD drives. DVD drives are also capable of reading DVD and CD discs. DVDs can have double layer and double sided. A single layer of a DVD ROM disc can store 4.7 GB of data. A double-layer and single-sided DVD can store 8.5 GB of data, while double-layered and double-sided DVD ROM media can store up to 17 GB.

Layer technology in DVDs is different from CDs. The pits on its surface are much smaller. DVD drives also use lasers to read surface areas. Since the width of the pits is smaller in DVD drives, the wavelength of the laser used is also smaller. DVD drives use a red laser.

1.1.6.3. BluRay Drives

It has been developed since the capacity which is required to carry high-definition movies is insufficient with CDs and DVDs. Drives that use blue light, not red light, as in CD and DVD technologies, to read optical discs. It is called BluRay because of the blue light. BluRay disc can be single or double layer. A single-layer BluRay Disc (BD-R) can store 27 GB, and a dual-layer BluRay Disc 54 GB.

IT'S YOUR TURN 7

A) Match the pictures below with the appropriate words.



1. (.....) Press eject button
2. (.....) Push tray until you close it
3. (.....) You will hear sound
4. (.....) Place the disc on the tray

B) Write T for True statements and F for False statements at the beginning of the following sentences.

1. (.....) A single-layer BluRay Disc (BD-R) can store 27 GB, a double-layer BluRay Disc 54 GB.
2. (.....) Optical drives use a special light system when reading and writing data.
3. (.....) CDs are double layered.
4. (.....) CD discs that are suitable for re-writing data are called CD-RW.
5. (.....) DVDs can be single or double layer.

C) Fill in the blanks in the sentences below with the appropriate words in the box.

Optical drive A double layer High resolution Larger Red light

1. and single side DVD has a capacity of 8.5 GB.
2. BluRay Drives are developed for transporting movies that require
3. Devices which are used to read or write data to optical discs are called
4. The capacity of BluRay discs is than the capacity of CD Discs.
5. is used to read optical discs in CD and DVD technologies.

D) Explain the words given below in your own words.

1. Optical Disc:
2. Double Layer:

1.2. COMPUTER COMPONENTS

1.2.1. Keyboard

Read the following text aloud and translate it into Turkish.

Keyboard; It is a hardware unit with keys on which letters, numbers, symbols, special characters and, if any, functional operations are included, which enables data entry to the computer. Keyboards are defined as Q and F according to the arrangement of the keys. There are wired, wireless and laptop types.

The function keys on the keyboard perform according to the program used. These keys do not write a character to the screen.

The keyboard sends a signal to the computer with the keys on it. The keyboard contains a simple microprocessor and buffer memory. When a key is pressed on the keyboard, the spring under the key is pressed, closing the silver nitrate-containing circuit in the charcoal layer underneath. This circuit sends a signal to the microprocessor inside the keyboard. The microprocessor sends this signal to the computer with the help of hex codes, and the computer understands which key was pressed thanks to these hex codes. Likewise, when the key is unpressed(key is up), a hex code is sent to the computer, which informs the computer that the key has been released.

However, this connection between the keyboard and the computer is not unidirectional. At the same time, the computer sends a signal to the keyboard. This allows setting of leds and key repetition like Num Lock.

Keyboard types vary according to usage environments, stylistic features and technologies. In terms of structural features, keyboards with rubber keys are mostly used. Rubber switch keyboards consist of 3 parts.

The first part is the case that protects the internal hardware of the keyboard. There are keys on the outside of this case to send signals from the user to the computer. It is usually made of plastic, and holds the keypad and internal hardware of the keyboard together.

The second part is the circuit board. This card is placed inside the case. It is produced from transparent plastic. Conductive paths are drawn on the circuit board.

The third part is the keyboard processor board. The connectors where the circuit boards are controlled and the interface unit (PS/2, USB, Bluetooth, etc.) where the keyboard is connected to the computer are located on this board.

Wireless keyboards; Considering the connection technologies, it can be grouped as infrared (IR), radio frequency (RF) and Bluetooth connection.

IT'S YOUR TURN 8

A) Match the numbers in the image below with the appropriate expressions in the box.

Enter Key Numeric Keypad Movement Keys Typewriter Keyboard Function Keys



1.
2.
3.
4.
5.

B) Write T for True statements and F for False statements at the beginning of the following sentences.

1. (.....) It is necessary to make a keyboard type setting from the operating system when a Q keyboard is attached to a computer using an F keyboard.
2. (.....) Keyboards have circuit boards.
3. (.....) Function keys write the character of that key to the screen.
4. (.....) There are conductive paths on the keyboard circuit board.
5. (.....) Wired keyboards are connected to the motherboard with PS/2 and USB ports.

C) Fill in the blanks in the sentences below with the appropriate words in the box.

Symbol Conductive Paths Laptop Circuit Board Connection Technologies

1. The is made of transparent plastic.
2. are drawn on the circuit board.
3. Keyboard types are wired, wireless and keyboards.
4. Wireless keyboards; they are grouped as infrared (IR), radio frequency (RF) and Bluetooth connection depending on the
5. A keyboard has sequential keys on which alphabet, number, special character and functional operations, if any, are included.

D) Explain the words given below in your own words.

1. Conductive Paths:
2. QKeyboard:

1.2.2. Mouse

Read the following text aloud and translate it into Turkish.

The mouse is the external hardware unit which is used to move the cursor on the screen to the desired position. A standard mouse has three buttons (left, middle, right). However, recently produced mice have a wheel-shaped button called a scroll. The scroll wheel moves the page up and down. However, the function of the scroll wheel can be changed from the mouse settings in the operating system or via the installed mouse software. There are optical, laser and mechanical (collective) variants. Mechanical mice have a heavy ball spinning at the bottom. As a result of this ball getting dirty with the dust around, the up and down movement of the mouse is restricted.

A light is emitted from the underside of optical and laser mice. This light source is used as the transmitter. It performs the cursor movement by processing the light movements reflected from the motion surface. Optical mice use LED as light source, laser mice use infrared laser. Optical mice use red, blue or infrared LEDs as light sources. When you look at the bottom surface of the mice, you will see the color of the LED light (except infrared).

Laser mice have higher sensitivity (resolution values) than optical mice. It operates by detecting microscopic parts (micro scratches) on transparent surfaces such as glass.

Mouse sensitivity is measured with the dpi (dots per linear inch) standard. Dpi is expressed as the number of dots per inch that a device can detect.

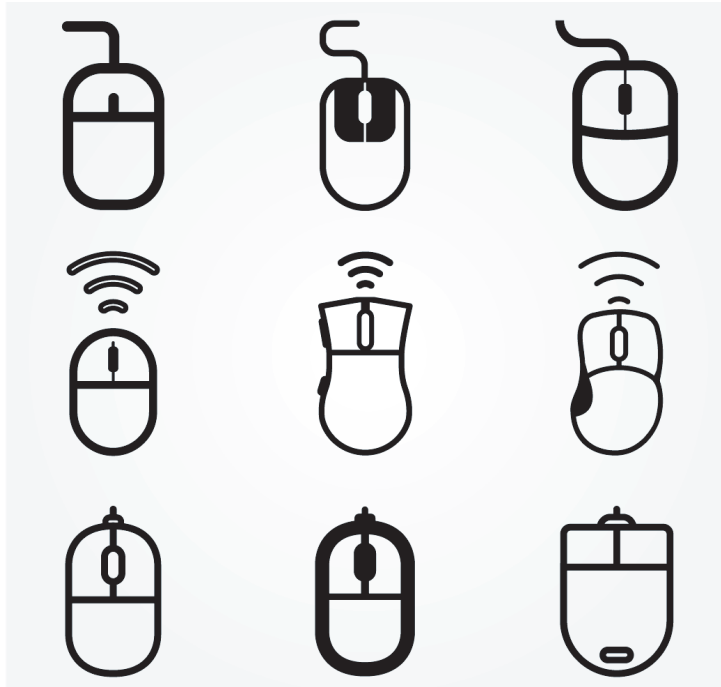

IT'S YOUR TURN 9

A) Match the numbers in the image below with the appropriate expressions in the box.

Scroll Wheel Right-Left Button Wires Out Optical Sensor Capacitors Resistors

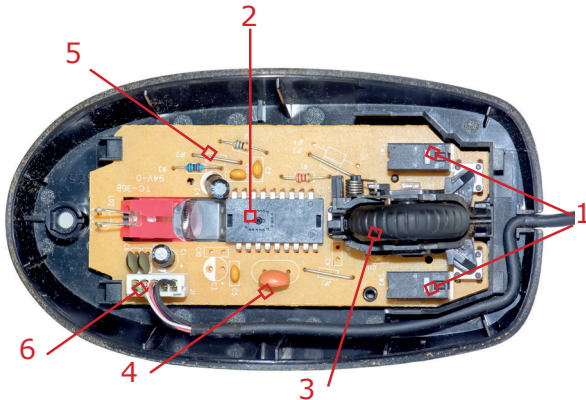

- 1.
- 2.
- 3.
- 4.
- 5.
- 6.

B) Write T for True statements and F for False statements at the beginning of the following sentences.

- 1. (.....) Mechanical mice have a ball for up and down movement.
- 2. (.....) Laser mice have higher resolution than optical mice.
- 3. (.....) Infrared laser is used as a light source in optical mice.
- 4. (.....) Dpi is the unit which is used to measure Mouse sensitivity.
- 5. (.....) Optic mice can work on glass surfaces.

C) Fill in the blanks in the sentences below with the appropriate words in the box.

Dots Scroll Wheel Light Source Resolution DPI (Dots Per Linear Inch)

- 1. The is made of transparent plastic.
- 2. are drawn on the circuit board.
- 3. Keyboard types are wired, wireless and keyboards.
- 4. Wireless keyboards; they are grouped as infrared (IR), radio frequency (RF) and Bluetooth connection depending on the
- 5. A keyboard has sequential keys on which alphabet, number,, special character and functional operations, if any, are included.

D) Explain the words given below in your own words.

- 1. Scroll Wheel:
- 2. Optical sensor:

E) PUZZLE

All the words to be filled are in the network topic.

Across

1. It is an electronic circuit element that contains all the parts of the computer and enables the communication of these parts.
2. Technology that allows to use an element without cables in a certain area.
3. It is a wire wrapped with an insulating material used in the transmission of electric current.
4. It is an external hardware element with letters, numbers and symbols on it that allows us to give commands to the computer.
5. It is an electronic circuit element that controls the operation of computer units and all data flow.

Down

1. It is the name given to all the touchable and visible parts that make up the computer.
2. The element which is used for the computer to be included in the network.
3. It is the memory used to quickly access data that can be read and changed.
4. It is an external hardware element that controls the movements of the cursor on the computer screen with the movements held in the palm, and also allows us to control the computer with click commands.
5. It is a memory element whose content is written at the time of production and cannot be changed again, only readable data is carried.

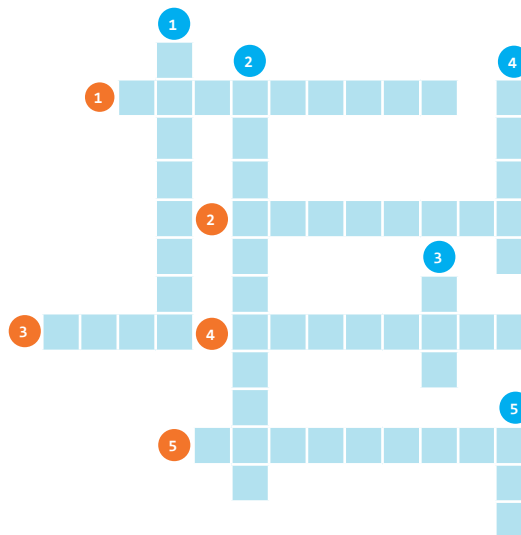

1.2.3. Monitor

Read the following text aloud and translate it into Turkish.

Computer monitors are output devices that display data processed on the computer in visual form. Monitors are divided into 4 according to the technology they use: CRT (Cathode Ray Tube), LCD (Liquid Crystal Display), plasma and LED. CRT and LCD screens are generally used in computer monitors. Plasma and LED screens are mostly used as television screens. However, especially in newly produced laptop models, LED screens are also used.

1.2.3.1. Cathode Ray Tube (CRT) Monitor

These monitors consist of a slightly cone-shaped screen. At the pointed end of the cone, there is an electron gun and a thin conductive wire (cathode). The screen consists of a phosphor coated layer. The thin conductive wire (cathode) is heated and electrons are thrown towards the screen surface by focusing them as a beam of light. Electrons hitting the phosphor layer on the screen surface shine and illuminate the pixels.

Beams of light ejected from the electron gun are emitted in three primary colors. These are the colors Red, Green and Blue. These colors are called RGB colors. Mixtures of these colors in certain proportions produce all intermediate colors. A 100% mixture of these colors creates white, and no light emission creates black. While the beam of light is hit into the phosphor layer on the screen, they pass through a perforated shadow mask. This mask ensures that the beam hits only the places where its color is desired.

1.2.3.2. Liquid Crystal Display (LCD)

The LCD screen works on the principle of reflecting light from a liquid crystal in a plastic layer. LCD is composed of many layers. These screens do not produce light by themselves. Therefore, it needs a light source (lamp) to illuminate the display panel. The light source is placed next to or behind the panel to create an easily visible image. LCD screens have the advantages of occupying a small space, low energy consumption, and no radiation.

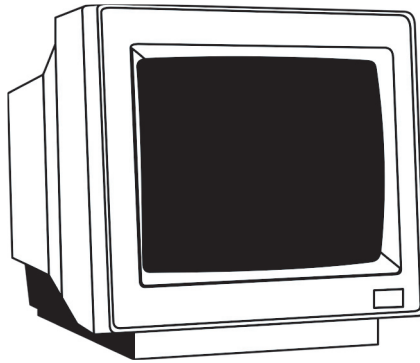

1.2.3.3. Plasma Display

Plasma panels consist of thousands of grid-shaped chambers filled with neon and xenon gases called plasma, located between two parallel glass sheets. When the electric current reaches the plasma in the chambers, an ultraviolet (UV) radiation is produced. UV radiation hits the phosphor layer and creates a pixel with one of the colors red, blue or green (RGB).

Hundreds of thousands of pixels like this one formed on the screen surface come together to form the image we see on the screen. Each pixel is illuminated separately. Therefore, the realism in colors is at the highest possible level. Plasma panels can produce more vivid and realistic colors than LCD panels.

Screen sizes can be very large . Plasma panels have low contrast ratio and consume more power. Since each pixel is illuminated individually in plasma panels, all of them being dark will ensure real black formation. Plasma screens' viewing angle is better than LCD screens. When looking at LCDs from the sides, darkness and discoloration occur in the image.

1.2.3.4. Led Display

LED displays can actually be thought of as derived from the LCD display. LED displays are backlit LCD displays. The big innovation in LED TVs has been occurred in the backlighting system. In LED TVs, a series of LEDs (Light-Emitting Diode) are used instead of the fluorescent lamp used as the backlight in LCD screens. The light for each pixel forming the image on the screen is provided by these LEDs. Lighting each pixel individually provides a clearer and brighter image.



IT'S YOUR TURN 10

A) Match the numbers in the image below with the appropriate expressions in the box.

One Plasma Pixel	Rear Plate Glass	Front Plate Glass
Dielectric Layer	Phosphor Coating in Plasma Cells	

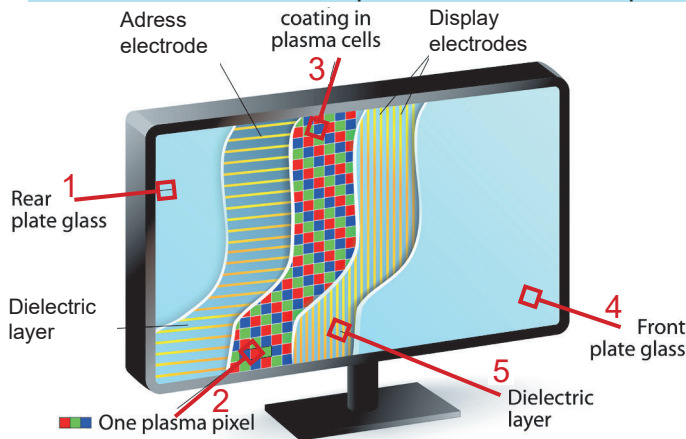

1.
2.
3.
4.
5.

B) Write T for True statements and F for False statements at the beginning of the following sentences.

1. (.....) The front surface of the CRT Screen is covered with a phosphor layer.
2. (.....) There is an electron gun on the LCD screen.
3. (.....) Plasma layer has thousands of phosphor-coated cells in which xenon and neon gases are evenly distributed between the two glasses.
4. (.....) Plasma monitor needs a light source.
5. (.....) LED displays are backlit LCD displays.

C) Fill in the blanks in the sentences below with the appropriate words in the box.

Layers	UV Radiation	Light Source	Cone	Low Contrast
--------	--------------	--------------	------	--------------

1. LCD consists of many
2. hits the phosphor layer, creating a pixel with one of the colors red, blue or green(RGB).
3. LCD screens need a
4. CRT monitors have a -shaped screen.
5. Plasma panels have a ratio.

D) Explain the words given below in your own words.

1. Light source:
2. Monitor:

1.2.4. Printers

Read the following text aloud and translate it into Turkish.

Printers are output devices used to print the data processed in the computer. According to the printing method, there are black and white or colored, dot matrix, inkjet and laser printers. Prices of printers vary according to speed, resolution, noise level, ease of use, page management technique, printing mechanism and quality.

1.2.4.1. Dot Matrix Printers

The writing process takes place by hitting the writing head (like a typewriter) on an ink ribbon mechanically. They make a lot of noise while working and can write more than one page using carbon paper. It has a low printing cost per page. Print quality is poor. In this printer, the number of pins and columns in the printhead is important. The number of pins indicates the number of dots that can be left on the paper at once. The number of columns indicates the number of letters to be printed in a line. It is especially used for printing invoices, waybills and receipts.

1.2.4.2. Ink Jet Printers

These are printers that work by spraying ink onto paper. The ink used for printing in inkjet printers comes from cartridges installed in the device. The printhead carries the black and color ink cartridges on it. Ink is ejected as it moves rapidly across the paper from left to right.

1.2.4.3. Laser Printers

Laser printers use a material called toner in the printing process. The developer roller is used to distribute the toner into the drum. The developer roller and toner container are together in one piece. While printing, toner powder is adhered to the paper by static electricity. Throughout the output of the paper, these toner powders are heated and melted on the paper, thus they complete the printing process.

Laser printers are often used, especially in jobs that require high precision and professionalism. These printers can also print on tracing papers and transparencies.

Toner particles are 2-30 micrometers in size. Toner particles can become suspended in the air. In this case, inhaled particles may pose a health risk. Therefore, the toner container should not be opened in living and working environments.

1.2.4.4. LED Printers

The operating system of LED printers is similar to laser printers. Both have a toner unit and both print by melting the toner. Laser printers use a laser beam that travels back and forth along the drum, while LED printers use a series of LEDs that flash the entire line at once.

1.2.4.5. 3D Printers

3D printers are machines that can transform digitally designed objects into concrete

objects using various materials at a certain scale.

In 3D printers, the graphic model of the object to be printed first is designed with various three-dimensional design programs. The 3D model created with these programs is converted into STL format. The process of converting the designed model into information that the printer can understand is called slicing. 3D printers work through a method called additive manufacturing. While slicing, head movements are coded for each layer of the model to be produced (files with STL extension are converted into G code.). The acquired head movement commands (G code) are transferred to the printer via USB or ethernet interfaces or via USB flash disk or SD card.

The material to be used is melted by heating the head of the printer. The designed object is created by being added together layer by layer. The consumable that melts and settles on the surface quickly freezes and turns into a solid form. Then all the layers are frozen and the 3D printed object is produced. This process may vary depending on the consumable used.

3D printers use SLA, DLP, SLS, FDM printing technologies. FDM is the most preferred printing technology in terms of device and printing cost. In 3D printers with FDM technology, filament is used as a consumable material.

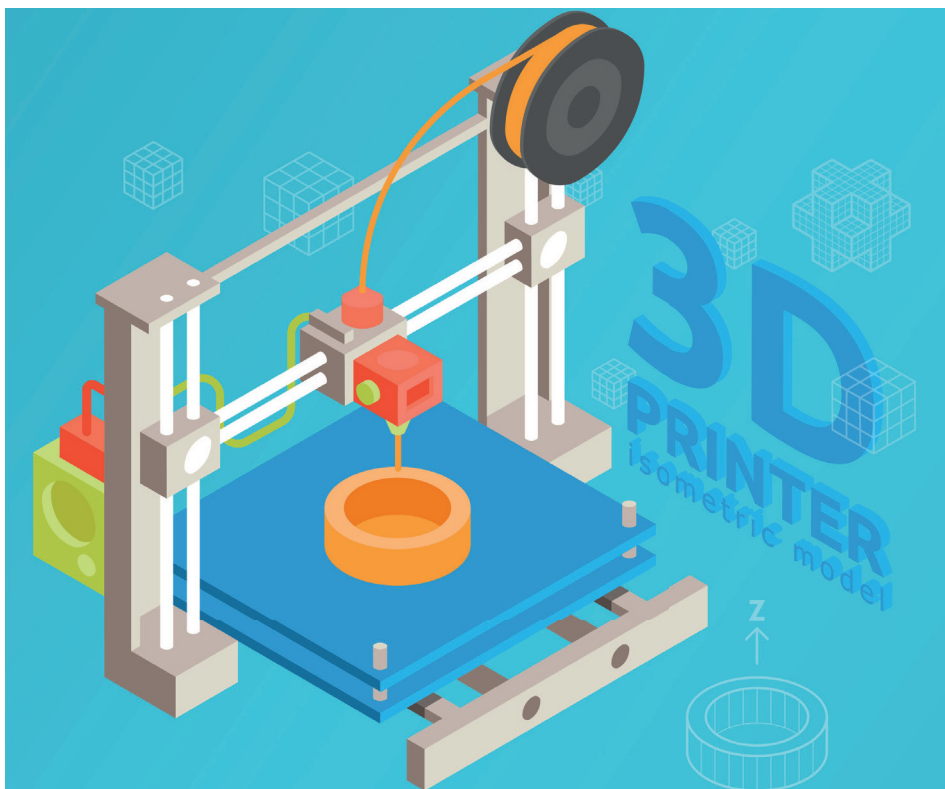

IT'S YOUR TURN 11

A) Match the numbers in the image below with the appropriate expressions in the box.

Paper Tray	Laser Scanning Unit	Photoreceptor DRUM
Toner Hopper		Developer Roller / Roles

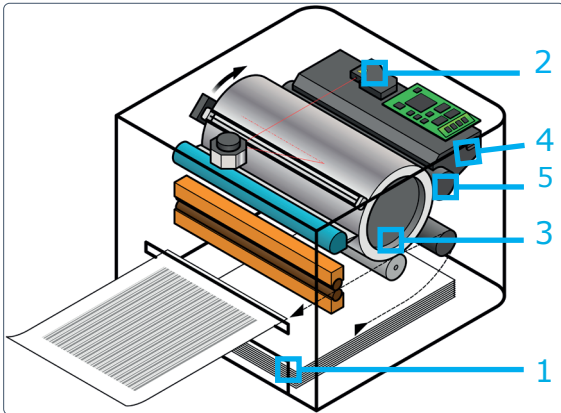

- 1.
- 2.
- 3.
- 4.
- 5.

B) Write T for True statements and F for False statements at the beginning of the following sentences.

- 1. (.....) Cartridge is used in inkjet printers.
- 2. (.....) The working system of LED printers is similar to laser printers.
- 3. (.....) The consumable material of laser printers is filament.
- 4. (.....) Slicing process is done for coordinating in LED printers.
- 5. (.....) The developer roller is used to distribute the toner to the drum.

C) Fill in the blanks in the sentences below with the appropriate words in the box.

Laser Printers	Working System	Graphic Model	Printhead	Toner Powder
----------------	----------------	---------------	-----------	--------------

- 1. of LED printers is similar to laser printers.
- 2. use a laser beam that travels back and forth along the drum.
- 3. In 3D printers, the printing process starts with the creation of the of the object to be printed.
- 4. In laser printers, is adhered to paper with static electricity.
- 5. The carries the black and color ink cartridges on it.

D) Explain the words given below in your own words.

- 1. Graphic Model:
- 2. Paper tray:

1.2.5. Scanners

Read the following text aloud and translate it into Turkish.

Scanners; They are devices that transfer color or black and white texts and pictures in various printed documents such as books, magazines, newspapers, photographs, and business cards to the computer environment.

All the details in the scanned area are obtained with the sensors in the scanners. CCD or CIS Chip is used as a sensor in scanners. CCD sensors are most commonly used ones today. Scanner components vary depending on the sensor used. CCD sensors are in the form of chips. CCD scanner consists of light source (lamp or LED), mirror, lens, optical sensor and stepper motor components. These sensors work as light sensitive in devices such as cameras, photocopiers or video cameras.

Color tone scanning is performed with green, red and blue colors. Therefore, the efficiency obtained from the scanner with a high color detection capacity is better.

Scanning starts with flashing light on the document from the light source. The document is illuminated for better scanning. The captured light is reflected from the document and falls on the mirrors. The reflected light is transferred to the lens through the mirrors. The lens focuses the transmitted light onto the CCD sensor. The light, which is converted to an analog signal by the CCD, is converted into digital signals with an analog-to-digital converter (ADC). And thus, the conversion of the scanned material is achieved. The stepper motor is used to move the scanning system back and forth in the horizontal plane.

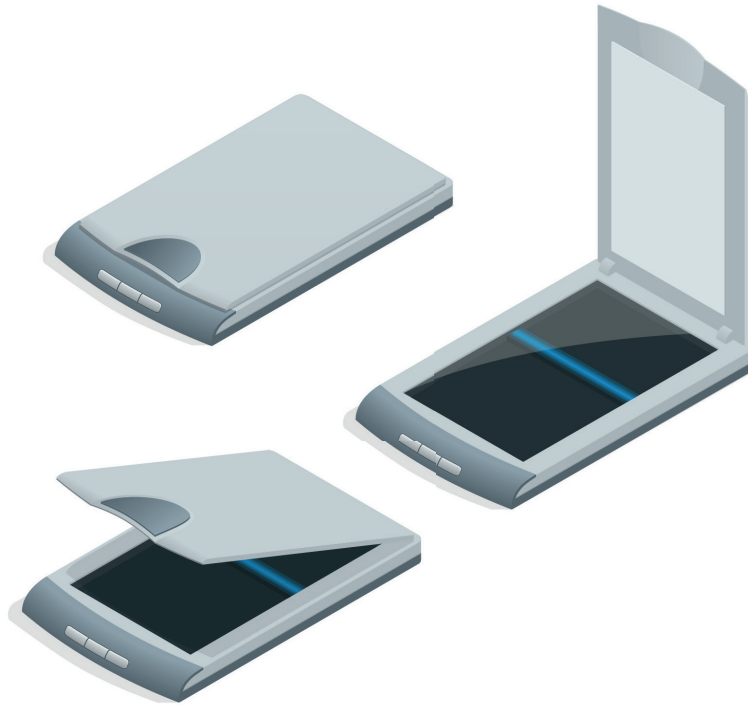

IT'S YOUR TURN 12

A) Match the numbers in the image below with the appropriate expressions in the box.

Document	Light Source	Lens	Mirror	Flatbed
----------	--------------	------	--------	---------

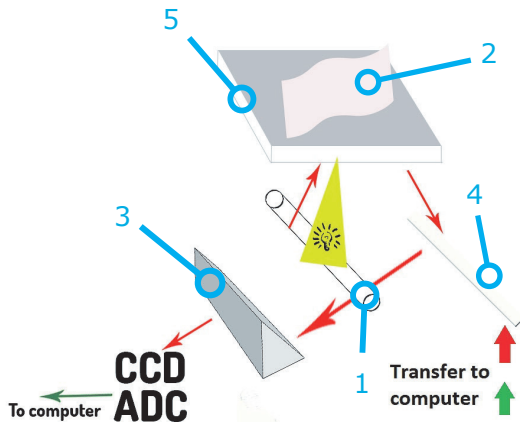

- 1.
- 2.
- 3.
- 4.
- 5.

B) Write T for True statements and F for False statements at the beginning of the following sentences.

- 1. (.....) Mirrors are used to transfer the reflected light onto the lens.
- 2. (.....) The stepper motor is used to move the scanning system back and forth in the horizontal plane.
- 3. (.....) CCD converts light into digital signal.
- 4. (.....) The scanning process starts with flashing on the document from the light source.
- 5. (.....) Mirrors are used to transfer the reflected light onto the lens.

C) Fill in the blanks in the sentences below with the appropriate words in the box.

Mirrors	Scanners	Analog-to-Digital Converter(ADC)	Light Source	Sensor
---------	----------	----------------------------------	--------------	--------

- 1. The light from the to the document is reflected from the document and falls on the mirrors.
- 2. transfer the reflected light onto the lens.
- 3. The light, which is converted to an analog signal by the CCD, is converted into digital signals with an and the scanned material is transformed.
- 4. The lens focuses the transmitted light and drops it onto the CCD
- 5. use CCD or CIS Chip as optical sensors.

D) Explain the words given below in your own words.

- 1. Mirror:
- 2. Document:

ASSESSMENT AND EVALUATION 1

Read the questions below and tick the correct answer.

1. Which of the following is the brain of the computer?

- A) Central Processing Unit B) Graphics card C) Main board
D) Power supply E) Ramdac

2. Which of the following is not a component of CPU?

- A) Arithmetic logic unit B) Cache C) Counters
D) Data bus E) IDE Connector

3. Which of the following is a feature of an inkjet printer?

- A) It is possible to print on more than one page with carbon paper.
B) It prints using toner.
C) Their printing speeds are quite slow compared to other printers.
D) In inkjet printers, the consumable is called a cartridge.
E) It uses a laser beam that moves back and forth along the drum in the printing process.

4. Which of the following is a Digital to Analog converter on the video card?

- A) Ramadc B) Ramdac C) RamGva
D) RamVga E) RamVideo

5. Which of the following defines the BIOS?

- A) To host hardware units on it
B) To store data
C) To install and start the operating system
D) To control the data flow
E) To provide faster startup

6. Which of the following is not among the functions of the motherboard?

- A) To ensure the communication of hardware parts
B) To control the data flow
C) To run the BIOS software
D) To carry hardware parts on it
E) To store data

UNIT **2**

**SOFTWARE
AND NETWORK**

**CONCEPTS IN
A FOREIGN
LANGUAGE**

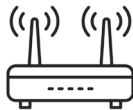
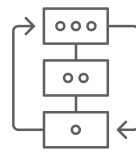
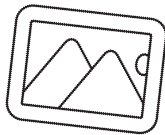

WWW



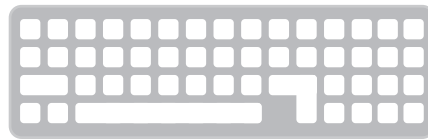
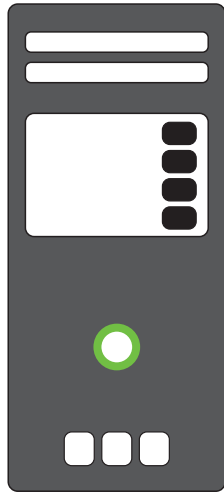

What will you learn?

In this unit you will be able to

- To express network concepts in a foreign language.
- To list network devices in a foreign language.
- To list network connection types in a foreign language.
- To express concepts related to software in a foreign language.
- To list software types in a foreign language.
- To explain the extensions used on the websites in a foreign language.
- To explain the basic concepts of graphics and animation.

Key Concepts

Network, Switch, Router, Server, Client, Software, Security, Domain, Hosting, Graphics, Animation, Programming.

2. SOFTWARE AND NETWORK CONCEPTS

PRE-READING ACTIVITY

Share your thoughts on the questions given below with your classmates.

1. What networks do you know around you?
2. What software do you use most often?
3. What web pages do you visit frequently?
4. What words do you know about web, graphics and animation?

2.1. NETWORKS

Connecting devices to each other for the purpose of sharing information is called a network. Networking is a technology that connects various devices for data sharing. The most widely known network is the Internet. The purpose of the network is data sharing. There are many types of networks. A network that connects computers directly to each other is called a peer-to-peer network.



The networks used by devices in the same environment such as home, classroom or office are called local area network (LAN). The network which is created by connecting personal devices to each other is called the Personal Area Network (PAN). The largest network formed by interconnecting many networks is called a Wide Area Network (WAN). Networks that are created between many LANs in a city or large campus are called Metropolitan Area Network (MAN). Networks that are set up through remote access, and where security must be at a high level, such as banks, are called virtual private networks (VPNs).

2.1.1. Types of Networks

Peer-to-Peer Network, LAN (Local Area Network), WAN (Wide Area Network), PAN (Personal Area Network), MAN (Metropolitan Area Network), VPN (Virtual Private Network)

IT'S YOUR TURN 1

A) Match the definitions (1-5) with the pictures (A-E).

1. (.....) Topology where all computers are connected via a single cable.
2. (.....) Topology in which machines are connected end-to-end around the circle.
3. (.....) Topology where machines are connected to each other by a switch or a hub.
4. (.....) Topology in which all machines are connected to each other end-to-end.
5. (.....) A type of topology that is a combination of two or more topologies.

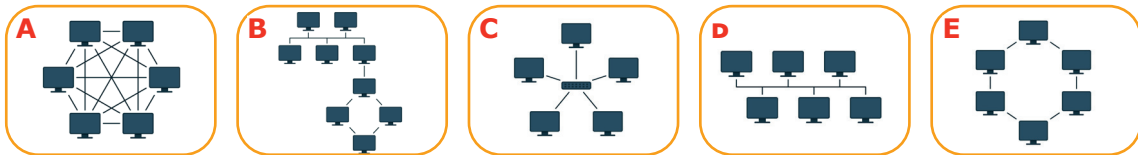

B) Write "T" for True statements and "F" for False statements at the beginning of the following sentences.

1. (.....) Secure networks used for remote access to computer networks are called VPNs.
2. (.....) Networks that connect computers in limited areas such as offices and schools are called wide area networks.
3. (.....) A network of personal devices is called PAN.
4. (.....) Networks created in a single unit such as laboratory, classroom, office are called Local Area Network.
5. (.....) Networks formed by connecting two computers to each other are called private virtual networks (VPN).

C) Fill in the blanks in the sentences given below with the appropriate words in the box.

WAN	Peer to Peer	MAN	VPN	Internet
-----	--------------	-----	-----	----------

1. The network in which two computers are connected to each other without central control is called
2. The computer networks used in a city or campus are called
3. The network formed by the interconnection of many local networks in a wide geographical area is called
4. The largest known network is called
5. A secure network technology that enables to establish a secure communication link between two different networks is called

D) Define the words given below with your own sentences.

1. Network:
2. Switch:

E) PUZZLE

All the words to be filled are in the network topic.

Across

1. It is a network hardware element that enables computers and other network elements to be connected to each other.
2. It is a network which is used to establish wireless connections between personal devices.
3. A network where two or more computers are interconnected to share data without the need for central control.
4. It is the exchange of data by connecting two or more computers with each other in a wired or wireless way.
5. It is a circular or hexagonal topology structure with independent nodes at the center.

Down

1. It is an electronic communication network that enables computer networks to be interconnected using a transfer control protocol called TCP/IP.
2. It is a type of topology where all devices in the network are connected to a central node or a device.
3. It is the type of topology where all the ends of the devices in the network are connected to each other.
4. It is the language used by computers connected to a network to communicate with each other.
5. It is a type of network topology where each node is connected to two other nodes and the signals on each node are transmitted over a single line.

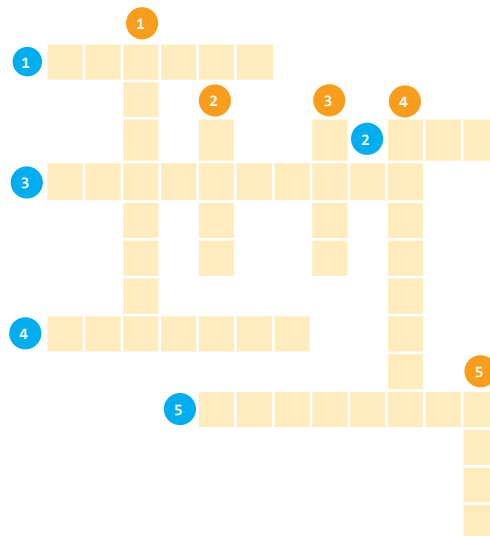

2.1.2. Network Connection Types

A wired or wireless connection is used to connect to the network in many places such as at home, school, etc.

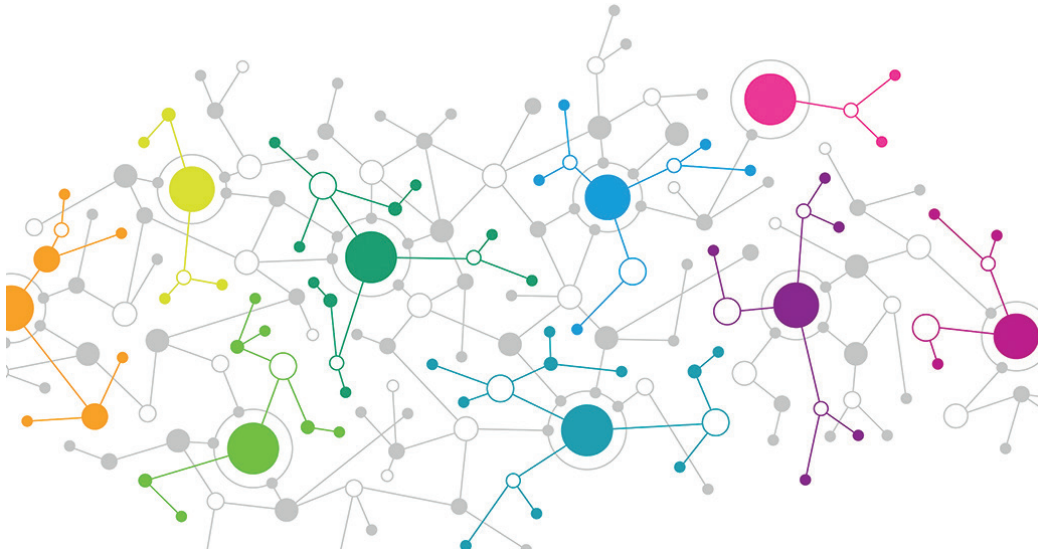

In wired connections; Coaxial cable, Twisted-Pair cable, Fiber optic cable are used. Coaxial cable is for audio and video transmission. Twisted-pair cable is the most commonly used cable in network setup. Twisted-Pair cables come in three types: UTP (Unshielded Twisted Pair), STP (Shielded Twisted Pair) and FTP (Foiled Twisted Pair). Fiber optic cables are used to transmit data over long distances at the speed of light.

2.1.3. Types of Cables

Cable, coaxial, twisted pair, unshielded twisted pair, shielded twisted pair, foiled twisted pair, fiber optic.

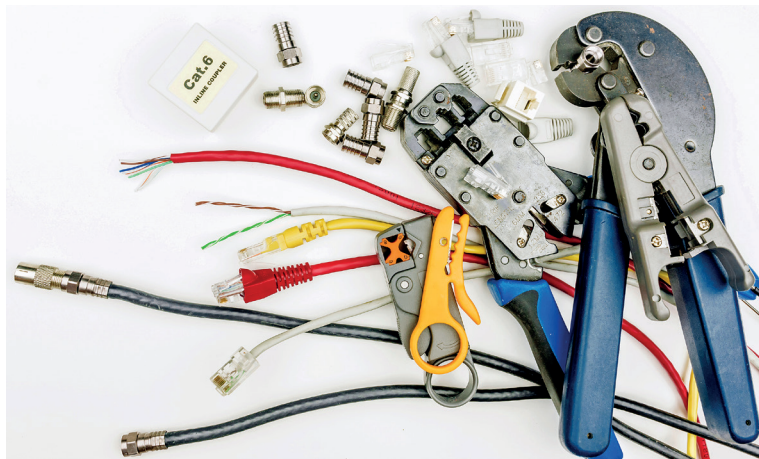

IT'S YOUR TURN 2

A) Match the definitions (1-5) with the pictures (A-E).

1. (.....) It is a cable developed to transmit low-power signals in environments where electromagnetic pollution is intense in audio and video transmission.
2. (.....) It is a cable type designed for data transmission over long distances.
3. (.....) It is a type of cable consisting of twisted pairs of wires.
4. (.....) It is wrapped in a foil covering the twisted pairs.
5. (.....) Twisted pairs are individually wrapped with foil to prevent electromagnetic interference.

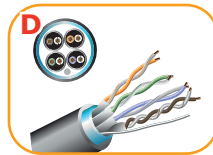
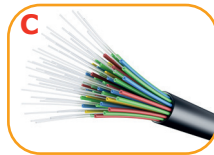
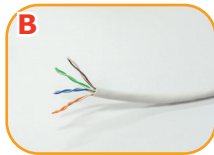

B) Write "T" for True statements and "F" for False statements at the beginning of the following sentences.

1. (.....) Fiber optic cables are used for intercontinental network connection.
2. (.....) STP (Shielded Twisted Pair) cables are used in audio and video transmission.
3. (.....) FTP (Foiled Twisted Pair) cable is used to prevent electromagnetic interference.
4. (.....) Cables that transmit data at the speed of light are called UTP (Unshielded Twisted Pair) cables.
5. (.....) Coaxial cable is used to transmit the sound and image coming from the satellite connection to the televisions.

C) Fill in the blanks in the sentences given below with the appropriate words in the box.

Twisted-Pair	Coaxial	Fiber Optic
Shielded Twisted Pair	Unshielded Twisted Pair	

1. Cable, whose usage areas are television, telephone networks and local area networks, is called
2. The most commonly used copper cable type in ethernet networks is called
3. The cable type which is unshielded, cheap and easy to install is
4. The cable type with twisted pair cables inside the protective sheath is called
5. The type of cable used to transmit at the speed of light over long distances is called

D) Define the words given below with your own sentences.

1. Coaxial:
2. Fiber Optic:

2.1.4. Network Equipment

The server is the central computer that shares resources and manages the network. The client is the computer that uses the resources and is managed by the server.

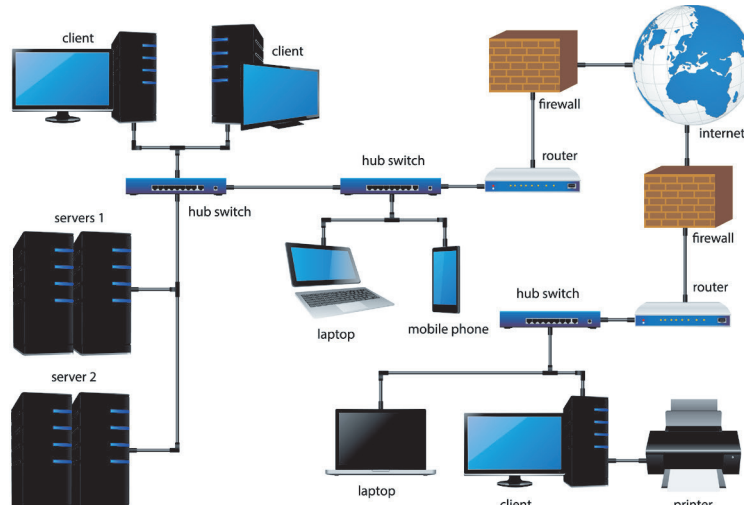

NIC (Network Interface Card) is used to include the computer into the network. Each card on the NIC (Network Interface Card) has a unique MAC (Media Access Control) number. In order to communicate on the network, computers need a unique IP (Internet Protocol) address and a MAC (Media Access Control) address. The oldest element used to set up a network of two or more computers is called a hub. The hub has left its place to devices called switches because it blocks the network traffic too much. Access Point device is used to increase the signal strength in wireless network connections. Access Point devices can be used to convert a wired connection to a wireless one, to carry the signal to a longer distance with the repeater feature, and to connect two networks wirelessly with the Bridge Mode feature. A router is used to connect two or more LANs to each other. Firewall devices are automatically used to block network traffic from a fake, unauthorized, suspicious or unknown source and protect it from attacks.

TCP/IP protocol is used to communicate over the internet. In the TCP/IP protocol, two protocols are used in communication, the unreliable UDP (User Datagram Protocol) is for audio and video transmission, and TCP (Transmission Control Protocol) is for lossless data transmission over the internet.

2.1.5. Network Devices

Network Interface Card(NIC), Media Access Control(MAC), Internet Protocol(IP), Hub, Switch, Access Point, Bridge, Router, Firewall, Transmission Control Protocol (TCP), UDP (User Datagram Protocol)

IT'S YOUR TURN 3

A) Match the problems given below with the appropriate solutions on the right.

1. It is the type of network in which each employee of the company works on the specified computer with their user name and password.

A
Switch

2. It is a device to be used to communicate all local networks used in the campus consisting of many buildings.

B
Server Client Systems

3. A device that should be used to add new computers to the wired network in the classroom.

C
Router

4. A type of network in which two computers are directly connected to each other without using any device.

D
Firewall

5. A security device which is used to prevent unauthorized access to the corporate network.

E
Peer-to-peer network

B) Write "T" for True statements and "F" for False statements at the beginning of the following sentences.

1. (.....) There is a need for a hub device to route networks.
2. (.....) There is a need for network interface card to include computers in the network.
3. (.....) The 48-bit address on the network card is called the IP address.
4. (.....) IP and MAC addresses are used for communication on the network.
5. (.....) User Datagram Protocol is used for lossless data transfer on the internet.

C) Fill in the blanks in the sentences given below with the appropriate words in the box.

Server	Network Interface Card(NIC)	Router
UDP(User Datagram Protocol)	Media Access Control(MAC)	

1. The card which is used to include the devices into the network is called
2. Devices which are used to communicate between two or more networks are called

Vocational Foreign Language

3. The fast but insecure protocol which is used for audio and video transmission on the internet is called
4. The unique address that identifies the device connected to the network on the internet or local network is called
5. The machine that serves the users in the network on which programs are installed and run is called

D) Define the words given below with your own sentences.

1. Router:
2. Wireless:

E) PUZZLE

All the words to be filled are in the network subject.

Across

1. Network connection type without a wire.
2. The largest area network.
3. Computer network topology where signals are transmitted over a single line, where each device is connected to two other devices.
4. A device that connects two or more local networks.
5. Secure private virtual network.

Down

1. The most commonly used network element for networking.
2. The technology that connects various devices for the purpose of data sharing.
3. The protocol used for the transmission of audio and video in the internet environment.
4. A computer that hosts shared resources on computer networks that users can access.

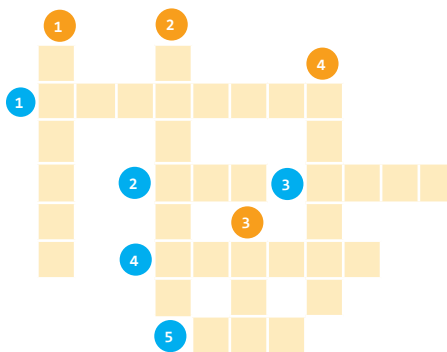

2.2. SOFTWARE

A computer consists of two units, hardware and software. Hardware is the general name of all physical parts of electronic devices that can be seen and touched by users. There are two types of hardware in a computer, internal hardware and external hardware. Internal hardware describes the parts inside a computer case or an electronic device. All parts that are visible to the naked eye are called external hardware.



Software is a general name given to the programs that we install on the computer. There are two types of software; system software and application software. The software which is required to use its hardware is called system software. System software makes the computer work. If the operating system software is not installed on the computer or the operating system software is damaged, the computer will not work. Operating system software is the software that provides communication between the hardware, application software and the user, and it works continuously from the moment the devices are started until they are shut down. WindowsXP, Windows10, Linux, Pardus, Android, IOS etc. are the most popular operating systems.

On the other hand, application software are programs written for the solution of problems on certain topics, which are installed in accordance with the needs of the users. Package programs are programs that people choose and install according to their own wishes, such as computer games and antivirus programs.

Operating systems such as computers, tablets, smartphones, etc. are seen in many technological devices. There are two types of operating systems: closed source or commercial software for which a license fee is paid, and open-source software, which can be modified if desired and used by the user without any fee.

There is also programming software used to create operating system software and application software. Operating systems and application software are all written in programming software.

2.2.1. Software Types

Operating System Software: It is the software that is required for the operation of electronic devices.

Licensed Paid Software: It is the software that allows you the right to use it for a fee.

Unlicensed Freeware Software: It is the software that is not charged any fee by its developers.

Trial Software: It is the software that can be used temporarily and can be purchased if liked.

Beta Software: It is the software given out to find out the problems and user experiences of the software under development.

Demo Softwares: It is the software that is given to users to test them by making certain features available.

Malware Software: Applications that can harm the operation of electronic devices and try to access files and information without permission are called malicious software.

Security Software: It is the software that is developed to prevent malicious software is called security software.

Office Software: It is the software that gathers all the software such as word processing, spreadsheet and a program presentation that a computer user may need.

File Compression Software: They are programs used to compress files to reduce their size and take up less space.

Portable Document Software: It is known as PDF. They are programs developed for reading and transporting documents containing text and images on different media and different devices without the need for any program.

IT'S YOUR TURN 4

A) Match the terms (1-5) with the appropriate definitions (A-E).

1. (.....) Trial Version

A. Software for which the license fee must be paid to try and continue to use it for free for a period of time.

2. (.....) Open source

B. Software with open source code that can be modified and used at any time without paying any fee.

3. (.....) Home version

C. Software that is fully available and usable.

4. (.....) Professional version

D. The most basic software that is required for the operation of an electronic device.

5. (.....) Operating system

E. Cheaper, available software without some simplified features.

B) Write "T" for True statements and "F" for False statements at the beginning of the following sentences.

1. (.....) Software developed to prevent malicious software is called security software.
2. (.....) Software that harms devices and uses files and information without permission is called demo software.
3. (.....) Software that is allowed to be used free of charge for a certain period of time is called open-source software.
4. (.....) The most basic software installed for the operation of computers is called operating system software.
5. (.....) The software for which no fee is charged by its developers is called Freeware Software.

C) Fill in the blanks in the sentences given below with the appropriate words in the box.

Hardware	Operating System	Freeware
Security Software	Application Software	

1. The software that can be accessed free of charge and customized by making changes is called
2. The basic software which is required for the use of electronic devices is called
3. All physical parts that can be seen and touched are called
4. The software which is used to protect electronic devices from malicious software is called

Vocational Foreign Language

5. The software which is installed on the computer in accordance with the needs is called

D) Define the words given below with your own sentences.

1. Freeware:
2. Software:

E) PUZZLE

All the words to be filled are in the software topic.

Across

1. It is expressed as a set of commands that enable a specified job to be done.
2. A harmful software is referred to as malware.
3. It is the type of software offered to users for use for a certain period of time.
4. It is a type of software that is distributed free of charge to promote programs sold for a certain fee to users or to test some features of the program in order to sell the program.
5. It is a general name given to all the internal and external parts that make up an electronic device.
6. It is a type of software that runs on the computer, manages hardware resources, and enables the user to communicate with the computer.

Down

1. It is a type of software developed to prevent malicious software.
2. It is a type of software that enables computers to be used in various jobs.
3. It is a type of software that is distributed without any charge by its developers.

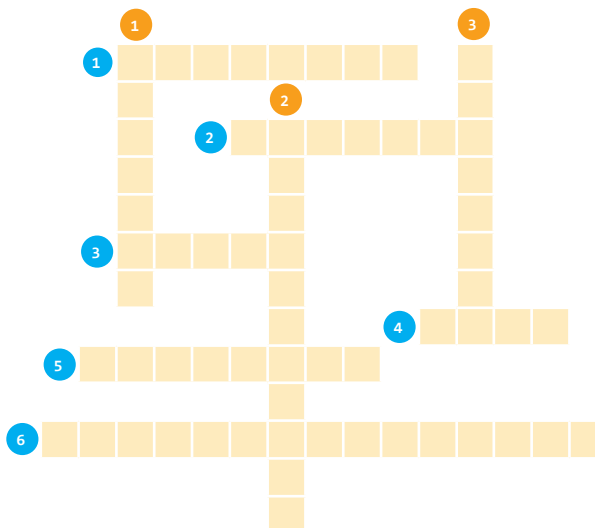

2.3. WEB, GRAPHICS AND ANIMATION

Web pages provide information and services to users in the form of text, images, videos and animations. To access web pages, the term WWW (World wide web) is prefixed. To view web pages in browsers, HTTP (Hyper Text Transfer Protocol) or HTTPS (Secure Hypertext Transfer Protocol) protocols come before WWW in the address line.



2.3.1. Web Pages

Websites are promotional and sharing tool shaped by graphic design and web software languages for individuals and businesses. Content is the most important thing when designing a website. Because the purpose of preparing the websites is to ensure that the information is accessible to others. When starting the website design, we need to know the content to be published on the site and design accordingly. Editing the design according to the content will also facilitate the creation of the website. When giving content to users, a simple and plain explanation should be made. Content should not be beyond the expectations of site visitors. If there is no content on a site with a beautiful design, no one visits that site, but a site with a poor design and good content always receives visitors.

Websites are located in hosting servers and can be accessed from the internet via domain resolving DNS servers.

Websites should be well prepared in terms of functionality and availability. Features of a good website:

- Web pages should be loaded fast.
- The menu on the website should be located in an easily visible place.
- There should be a link to the main page from the site logo on the page.
- There should be a link from each page to the main page.

Vocational Foreign Language

- There should be links in the sections to reach the inner pages.
- The website should have a contact information and a contact form to communicate.
- Important words should be highlighted in bold or in special colors.
- If the content is too much, there should be a search box.

From the words below, mark the ones you frequently encounter in the programs used while creating web pages. Use the words you marked in a sentence.

<input type="checkbox"/>	Design	<input type="checkbox"/>	Item
<input type="checkbox"/>	Source	<input type="checkbox"/>	Add
<input type="checkbox"/>	Split	<input type="checkbox"/>	Font
<input type="checkbox"/>	Toolbox	<input type="checkbox"/>	Paragraph
<input type="checkbox"/>	Insert	<input type="checkbox"/>	Bullets and Numbering
<input type="checkbox"/>	Select	<input type="checkbox"/>	Position
<input type="checkbox"/>	Delete	<input type="checkbox"/>	Convert to Hyperlink
<input type="checkbox"/>	Table	<input type="checkbox"/>	Align
<input type="checkbox"/>	Modify	<input type="checkbox"/>	Make Same Size
<input type="checkbox"/>	Merge	<input type="checkbox"/>	Remove
<input type="checkbox"/>	Cells	<input type="checkbox"/>	Formating
<input type="checkbox"/>	Row	<input type="checkbox"/>	Breakpoint
<input type="checkbox"/>	Column	<input type="checkbox"/>	Try-Catch-Finally

IT'S YOUR TURN 5

A) Match the statements (1-5) with the pictures (A-E).

1. (.....) Frame color is the picture with blue color.
2. (.....) The frame is the picture with double blue lines.
3. (.....) It is the picture with underlined texts.
4. (.....) It is the picture with an overline on the text.
5. (.....) It is the picture with a strikethrough on the text.



B) Write "T" for True statements and "F" for False statements at the beginning of the following sentences.

1. (.....) Bold style is used to bold the texts on the websites.
2. (.....) Underline style is used to write italic texts on websites.
3. (.....) Right align icon is selected to align the texts used on the websites to the center of the page.
4. (.....) Convert to Hyperlink command is used to connect from one website to another website.
5. (.....) Center text icon is selected to align the texts used on the web sites to justify on the page.

C) Fill in the blanks in the sentences given below with the appropriate words in the box.

Source mode	Merge	Hyperlink	Align	Bullets and Numbering
-------------	-------	-----------	-------	-----------------------

1. When editing content on web pages, the command is used to justify the text within the page.
2. The is used to create web pages with programming languages.
3. In order to link the desired text on the web pages, the command is used.
4. When creating content on web pages, the command is used for listing.
5. To combine columns in a table created on web pages, the command is used.

D) Define the words given below with your own sentences.

1. E-Commerce:
2. Database:

E) PUZZLE

All the words to be filled are in the software topic.

Across

1. It is the general name of the sites that provide buying and selling services over the Internet.
2. It is the official name of web addresses.
3. It is the protocol that regulates the secure sending and publishing of files over the internet.
4. They are the spaces where structured information or data is stored.

Down

1. It is a language which is used to create web pages on the Internet.
2. The content of web pages is a type of website that can be updated and changed according to the user.
3. It is the process of backing up files and databases on the computer or server.
4. It is the type of website that does not change according to the users, and created for promotional purposes or to provide information on any subject.
5. It is the type of interface where only commands are written while creating the website.

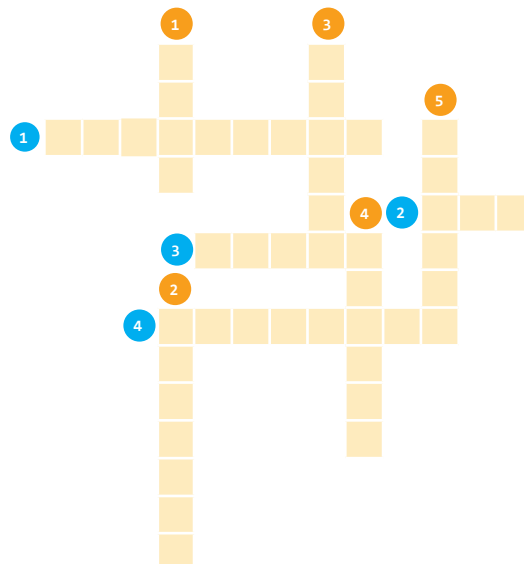

2.3.1. Website Domain Extensions

The names used to specify the address of the websites are called "domain names". Web pages are accessed by converting domain names to IP through Domain Name Server machines. If there were no such concept as a domain name, it would be necessary to write IP addresses instead of web addresses in order to reach web pages.



Domain names and hosting companies are required to publish websites. Hosting is the service of hosting the content of web pages on it. Domain is the name used to access the website.

There are many companies that provide domain and hosting services to publish web pages. We need to access any of these companies on the internet and do the following operations in order;

1. Select a reliable hosting and domain authority.
2. Open the domain checker tool.
3. Search by querying your domain name.
4. Select the best available domain name.
5. Choose a hosting according to the footprint of your website.
6. Complete the registration required for the hosting and domain you have chosen.
7. Complete the payment if you transacted from a paid company.
8. Verify your new domain address.

2.3.2. Domain

The domain extension is used to determine the category or country code of the website.

They are divided into different groups to publish websites for internet affiliates. Whichever group the website belongs to, the domain address includes the group-specific abbreviation at the end of the address.

If the web address belongs to a special-purpose service such as ftp, it is usually indicated with an abbreviation at the beginning of the web address.

The following list shows some abbreviations used in addresses and what they mean:

- **.com:** It is used for general and commercial matters.
- **.net:** It is used by Network and Service providers.
- **.org:** It is used for organizations.
- **.biz:** It is used for business related matters.
- **.coop:** It is used by cooperatives.
- **.edu:** It can be taken by educational institutions such as universities and colleges.
- **.gov:** It is used by government institutions.
- **.info:** information. It is used for information sites.
- **.int:** It is reserved for international organizations.
- **.jobs:** It is prepared for sites that post job and worker postings.
- **.mil:** military. It is reserved for military organizations.
- **.mobi:** Mobile. It is used in website construction for mobile phones.
- **.museum:** It is reserved for museums.
- **.name:** It is reserved for personal sites.
- **.pro:** professional. It is reserved for professionals.
- **.travel:** It is used for travel agencies and travel services.

IT'S YOUR TURN 6

A) Match the statements (1-5) with the pictures (A-E).

1. (.....) It is the domain extension of the websites of military fields.
2. (.....) It is the domain extension of general and commercial websites.
3. (.....) It is the domain extension of university websites.
4. (.....) It is the domain extension of websites belonging to government institutions.
5. (.....) It is the domain extension of the websites created for information purposes.



B) Write "T" for True statements and "F" for False statements at the beginning of the following sentences.

1. (.....) The domain extension reserved for the websites of professionals is job.
2. (.....) The domain extension used in websites prepared for organizations is net.
3. (.....) The domain extension used in websites prepared for international organizations is org.
4. (.....) The hosting service of the contents of the websites is hosting.
5. (.....) The domain extension used in websites prepared to give information about a subject is us.

C) Fill in the blanks in the sentences given below with the appropriate words in the box.

Hosting	Domain	Ftp	Edu	Http
---------	--------	-----	-----	------

1. The name registered and taken to access the web pages is called
2. The domain extension used to publish a university website is
3. It is put at the beginning of the website created for file sharing is
4. When you type the web address in your internet browser, the protocol will appear automatically.
5. The hosting service on all the content of the websites is called

D) Define the words given below with your own sentences.

1. Domain:
2. Hosting:

2.3.3. Graphics and Animation

The representation of an event or an image on a surface is called graphics. Photos, drawings and all other images are graphics. Graphic design is a creative process that involves organizing text and images on a perceptible and visible plane, two-dimensional or three-dimensional, in order to convey a message, develop an image, or visualize a thought.

Graphic design is the visual design of various products and activities such as websites, advertisements, books, magazines, posters, computer games, product packaging, banners, corporate communication and corporate identity.



It is used in many areas such as graphic design, website, printing, animation, advertising and promotion. Designs are the transfer or display of ideas, thoughts or the desired message through technological devices by blending talent with imagination.

Graphic design applications can export documents as PDF or HTML web pages. Pictures consist of frames and padding. Frame-related changes are made via the Stroke Panel. The inner part of the frame is called padding. Gradient is the most used feature in the filling. With the gradient, transitions can be arranged between two or more colors as desired.

All prepared designs consist of layers. Images can be changed easily with many features such as blurred, feather or soft at the edges. Also, brightness adjusts how bright and dark the image is. Contrast increases the number of black and white pixels in the image. The Highlights feature adjusts how bright or dark to be the bright and dark parts of the image. The Shadows tool allows bringing out the details of the darker parts of the shadow. With Saturation, the colors in the image can be made more prominent, and the image can be made black and white by reducing the saturation value.

Animation is a moving image obtained by displaying several images in quick succession. Animation is a software that makes frame-based animation. Animations are created by changing and playing frames in time.

IT'S YOUR TURN 7

A) Match the terms (1-5) with the definitions (A-E).

1. (.....) HTML

A. It is an expression defined in code writing and can take different values in it.

2. (.....) CSS

B. It allows displaying Internet pages on our computers.

3. (.....) Insert

C. Cascading Style Sheets is a markup language used for formatting text and formats alongside HTML.

4. (.....) Browser

D. It is the SQL code for creating a new data entry into the database.

5. (.....) Variable

E. It is a coding language developed to create websites.

B) Write "T" for True statements and "F" for False statements at the beginning of the following sentences.

1. (.....) Animated pictures can be created with GIF format.
2. (.....) Canvas color can only be set once.
3. (.....) Ruler and guides assist the user for alignment.
4. (.....) The order of the objects in the layer can be set.
5. (.....) In image processing software, texts can only be written from left to right.

C) Fill in the blanks in the sentences given below with the appropriate words in the box.

Saturation Gradient Soft at The Edges Grid Brightness

1. The grid lines used to indicate a reference point when placing objects in the workspace are called
2. The tool used to obtain a new color by switching among many colors is called
3. The tool used to highlight the image color is called
4. The tool used to select and soften the borders of the image is called
5. The tool used to adjust the range of brightness and darkness in the image is called

D) Define the words given below with your own sentences.

1. Animation:
2. Browser:

E) PUZZLE

All the words to be filled can be found in the graphic and animation topic.

Across

1. It is a moving image obtained by displaying several pictures in a quick succession.
2. The stage of drawing and creating a picture or object is called.
3. It is the tool that allows to adjust the brightness value of the picture.
4. It is the tool used to make colors on the image clearer or black and white.
5. It is the tool used to make the picture dark.

Down

1. It is the tool that regulates transitions between two or more colors as desired.
2. It is the tool for adjusting the brightness and darkness of the image.
3. It is the tool used to show parts of dark shadows.
4. It is the tool used to set the outer frame of the shape.
5. It is the tool used to blur the desired part of the image.

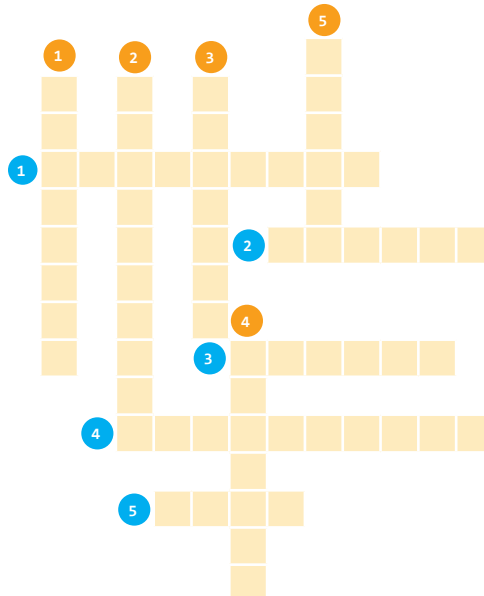

2.3.4. Basic Concepts of Graphics

Read the text aloud in class and translate them into Turkish.

1. **Pixel:** Images on the screen consist of dots. The dots are in the form of small squares. Small square dots can be seen when photos are enlarged. Small dots on the screen are called pixels. A pixel consists of a mixture of red, green and blue colors. Bitmap (pixel-based) image programs use pixels as a unit of measure. Pixel density is directly proportional to image clarity. Having the high pixel density increases the file capacity.
2. **Dot and Dot Pitch:** Each of the red, blue or green colors that make up the pixel is called a dot. The distance between the colors in a pixel is called the dot pitch.
3. **Resolution:** The pixel density of an image, or PPI (Pixel Per Inches), is the number of pixels in 1 square inch. (1 inch = 2.54 cm)
4. **DPI (Dot Per Inches):** On output devices, the number of pixels dotted (i.e. printed) or displayed per 1 inch is called DPI.
5. **Pixel-based graphics - Bitmap:** The picture created by the pixels is called a bitmap.
6. **Vector-based graphics:** Vector-based images are not resolution dependent.

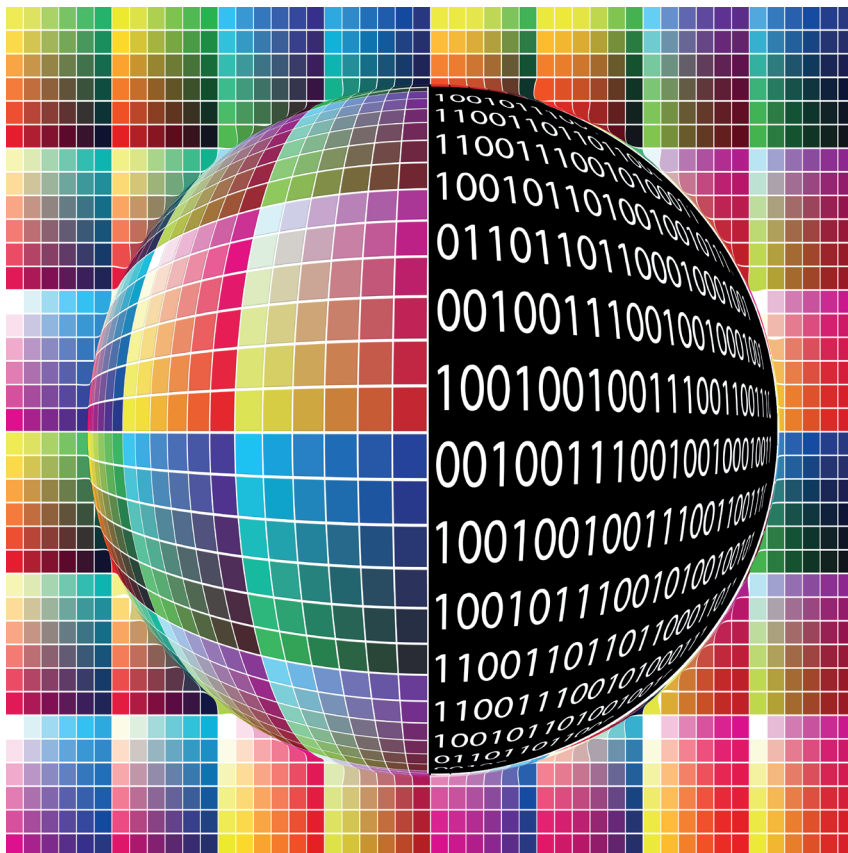

Vocational Foreign Language

Every point of the design is a digital image consisting of mathematical functions and curves. This means that when the size of the image is changed, they are calculated and redrawn. For this reason, there is no loss or loss of quality in the image. Since pixel images are resolution dependent, they are subject to loss of quality (pixelization) as their size increases.

Bitmap-based images (JPG, BMP, PNG, GIF, etc.) are created with pixel-based programs, while vector graphics (AI, CDR, PDF, EPS, SVG, etc.) are created with vector-based programs. Vector graphics are widely used in fields such as company logos, pictures with text, drawings that require technical and precise features.

Vector format is not of photo quality. Bitmap graphics, on the other hand, consist of millions of colors. It provides a flawless image up to the defined size. Unlike the vector format, the bitmap graphic has a resolution problem and can only be used in the produced size.

IT'S YOUR TURN 8

A) Match the definitions (1-5) with the terms (A-E).

1. (.....) It is the number of pixels that can be displayed on the screen.

2. (.....) It is the smallest dot on the screen.

3. (.....) Each of the red, blue and green colors that make up the pixel.

4. (.....) It is the distance between pixels.

5. (.....) It is a type of graphics that does not have a resolution problem.

A Pixel

B Resolution

C Dot Per Inches

D Vector-Based Graphic

E Dot

B) Write "T" for True statements and "F" for False statements at the beginning of the following sentences.

1. (.....) The number of pixels that can be displayed on the screen is called resolution.

2. (.....) PPI is the unit of resolution.

3. (.....) Vector-based painting programs use pixels as a unit of measurement.

4. (.....) The number of dots per 1 inch when the picture is in print is called DBI.

5. (.....) Pixel density reduces the capacity of the file.

C) Fill in the blanks in the sentences given below with the appropriate words in the box.

Width	Density	Mixture	Clearer	Dot Pitch
-------	---------	---------	---------	-----------

1. The meaning of 800 x 600 resolution is 800 pixel and 600 pixel height.
2. Pixel is the number of pixels in 1 square inch.
3. A pixel is the of red, green and blue colors.
4. If the pixel density is increased, the image becomes
5. The distance between the colors in a pixel is called

D) Define the words given below with your own sentences.

1. Resolution:
2. Pixel:

E) PUZZLE

All the words to be filled can be found in the graphic and animation topic.

Across

1. It is the pixel density of an image.
2. Screen size is a unit of measure.
3. The word describing the size of a picture from top to bottom.
4. Images created with pixel-based programs.

Down

1. The distance between the colors in a pixel.
2. A word describing the size of an image from left to right.
3. The word describing the smallest point out of the dots that displayed on the screen.

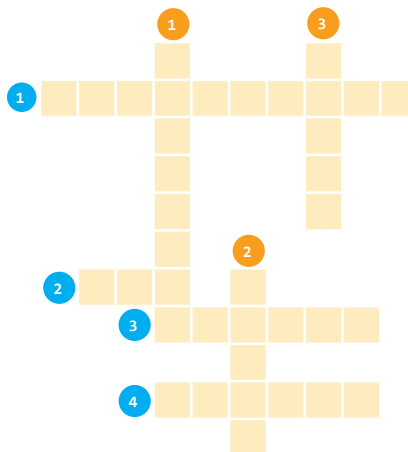

2.3.5. Image Formats

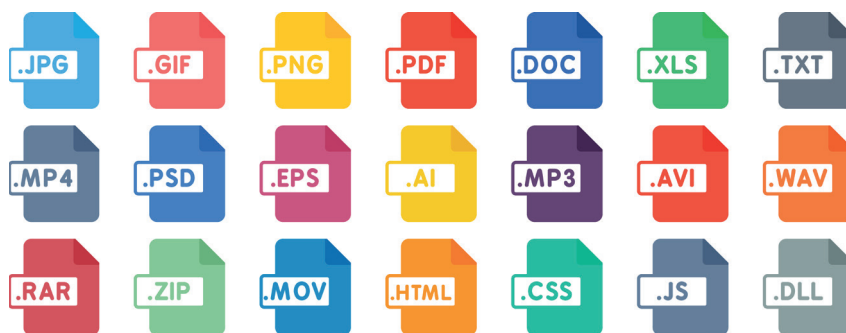

Some of the commonly used image formats are

PSD: PSD is an image processing format in multi-layered form. A PSD file can be converted to different format files using related programs.

TIFF: The TIFF format is a common file format between computers. It is supported by all programs. TIFF File is an extremely flexible and editable file format. Thanks to the page format support, many images can be included in a TIFF file.

TIFF Files can do lossless image storage. Thanks to this feature, they are used to create archive files and suitable for images with high color depth.

JPG: JPG format is widely used. It is seen as one of the most ideal extensions especially for photos. JPG files are capable of reducing the overall file size to 5% of the size. After this compression process, some tiny details of the image disappear.

The feature of JPEG or JPG format is that it contains true color values. Therefore, it is used for photographic (linear/non-graphical) imaging. It is used on websites because of its good quality and small size.

GIFs: Graphics Interchange Format (GIF) files are widely used on the Internet. It provides very good compression for documents with a small number of colors (1 to 8 bit).

PNG: PNG format is a newer format than GIF and JPG. There is no compression in this format. It supports high quality images without loss.

PDF: PDF Portable Document Format stands for portable document format. It is a file format that can be used in all digital media separately from the contents such as operating system, font or image. Files called as PDF are used in many fields such as books, documents and official documents. It is a file layout that can be easily read on phones and tablets.

EPS: The EPS format is supported by almost all drawing and page editing programs.

BMP: The BMP file format contains uncompressed data information valid for each pixel in the image.

IT'S YOUR TURN 9

A) Match the definitions (1-5) with the appropriate terms (A-E).

- 1. (.....) Photoshop program is a default file format.
- 2. (.....) It is a file format with good quality and small size used on websites.
- 3. (.....) It is a file format that contains both text and graphics.
- 4. (.....) It is a digital file format for creating portable and printable documents.
- 5. (.....) It is the file format used to create animated images on web pages.

- A** GIF
- B** EPS
- C** PSD
- D** PDF
- E** JPG

B) Write "T" for True statements and "F" for False statements at the beginning of the following sentences.

- 1. (.....) PNG file format is the extension of animated pictures.
- 2. (.....) PDF file format is usually just an extension of reading documents.
- 3. (.....) PNG file format is the commonly used file extension for images.
- 4. (.....) JPG is the file extension used for high quality images without compression.
- 5. (.....) TIFF is the file extension supported by all computers.

C) Fill in the blanks in the sentences given below with the appropriate words in the box.

BMP	TIFF	PDF	JPG	PNG
-----	------	-----	-----	-----

- 1. The extension is used to store digital photos and images with 24-bit color support.
- 2. The extension is used to store graphics on web pages.
- 3. The extension is used for the image file saved in high quality graphic format.
- 4. The extension is used for portable and read files.
- 5. The extension is used for files that retain the features of the image without compression.

D) Define the words below with your own words.

- 1. Interchange:
- 2. Portable:

2.1. BASIC PROGRAMMING CONCEPTS

Python is undoubtedly one of the most popular programming languages in recent years. Developed by Guido Van Rossum, this open-source and free language provides significant convenience to programmers. Before talking about the advantages of Python, it is useful to mention the concepts related to programming. An algorithm is defined as a way designed to solve a particular problem. Algorithms can also be expressed with forms. These formal expressions are called flowcharts (diagrams). Programmers start by visualizing the algorithm and flowchart. While the algorithm is the same in all programming languages, the syntax rules differ. Python is also an extremely easy language to write. This is the reason for the rise of Python in recent years.

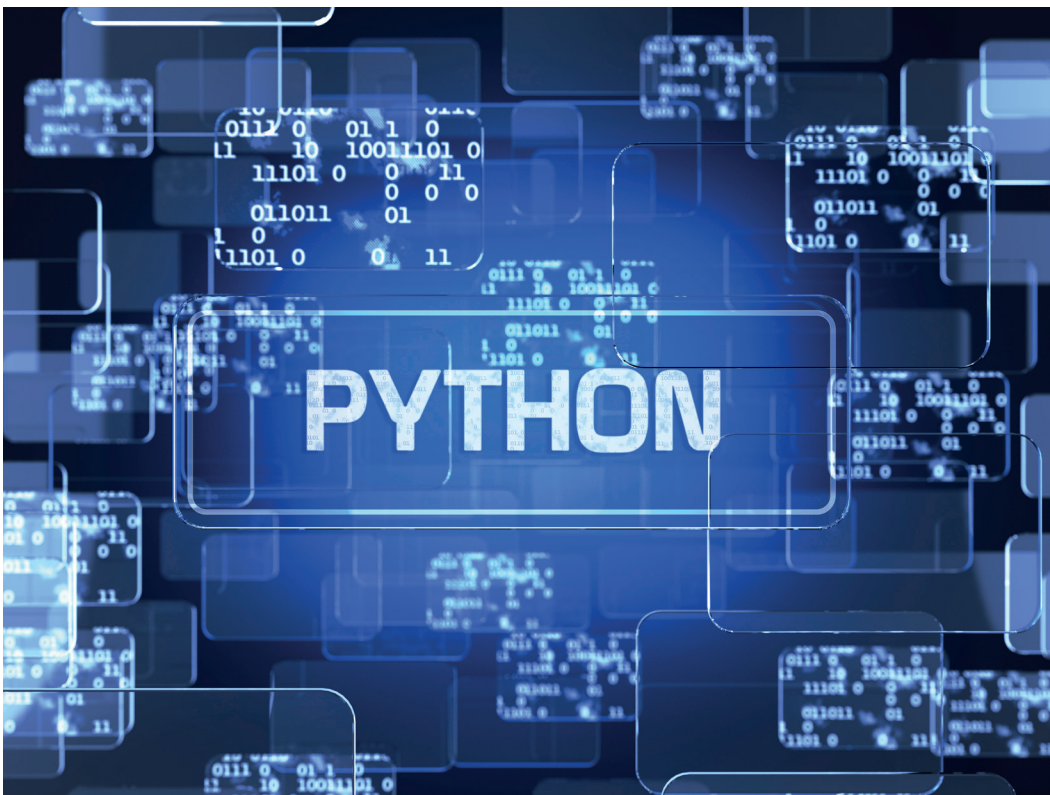

Code editors can be used to make writing Python easy and fun. Thanks to the code editors, you can color the codes, see the errors more easily and benefit from features such as auto-completion. You can make it easier to remember important key points by adding comment lines. With an internet search, you can find code editors with different features. Code editors take up less space on your computer and run fast. IDEs (Integrated Development Environment) are more advanced solutions. IDEs, which also contain compilation, interpretation and debugging features, are important tools for software development.

IT'S YOUR TURN 10

A) Match the terms (1-5) with the definitions (A-E).

1. (.....) Syntax	A. A diagram showing a process, system, or computer algorithm.
2. (.....) Print()	B. It is a file extension in Python.
3. (.....) py	C. It is software developed for programmers to code applications easily.
4. (.....) IDE	D. It is the command that allows writing to the screen in Python.
5. (.....) Flowchart	E. The rules that define the structure of a language.

B) Write "T" for True statements and "F" for False statements at the beginning of the following sentences.

1. (.....) Python is one of the popular programming languages of the last period.
2. (.....) It is necessary to create different algorithms in each programming language.
3. (.....) The visual expression of algorithms is called flowchart.
4. (.....) IDEs are tools with more features, including a code editor.
5. (.....) There is only one code editor available for Python.

C) Fill in the blanks in the sentences given below with the appropriate words in the box.

Compiler	Algorithm	Syntax	Code Editor	Comment Line
----------	-----------	--------	-------------	--------------

1. In the Python programming language, # sign is used to add in a single line.
2. In programming, the way to the solution of a problem is expressed by
3. which is simpler than IDEs, makes it easier to write code.
4. The unique writing way of each programming language is called
5. translates source code written in a programming language into another language.

D) Define the words below with your own words.

1. Algorithm:
2. Machine Learning:

E) PUZZLE

All the words to be filled can be found in the graphic and animation topic.

Across

1. It is a series of a command written in order to operate a computer system or electronic circuit.
2. It is the sequential expression of the steps to be followed in order to do a task correctly.
3. A set of operations which are used to tell computers which actions to perform in what order.
4. It is a multidisciplinary field that uses scientific methods, processes, algorithms and systems to get information and insights from data.
5. It is the section used to inform the person who examines the code, such as what the code in the program does and how it does what it does.

Down

1. A common type of diagram that shows algorithms and operations in boxes of different types connected by arrows.
2. It is a general purpose language that can be used for many applications.
3. It is software that translates source code written in a programming language into another language.
4. They are the rules that must be followed to write code in a programming language.
5. It is software developed for programmers to code applications more easily.

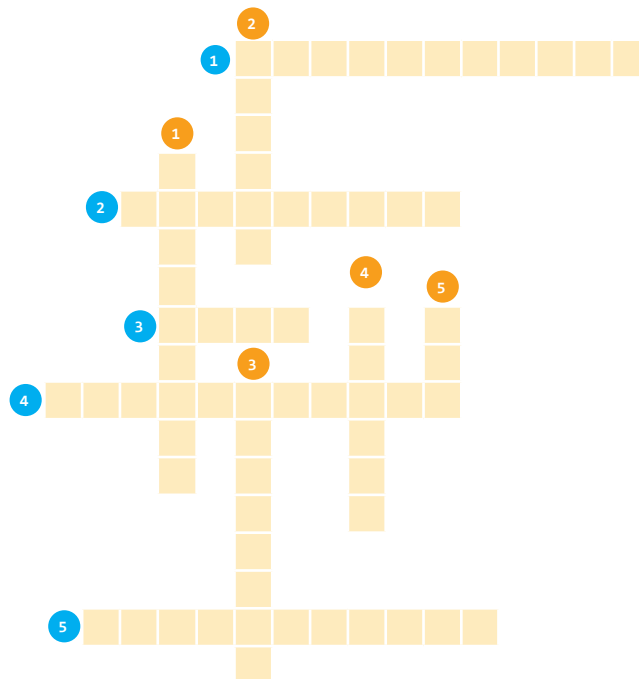

Data science; It is a field that brings together statistics and programming and has gained importance in recent years. Python is also one of the preferred languages for data science. The multitude of libraries that can be used especially for data science makes Python stand out. These libraries are also extremely useful for machine learning.



Research homework: Research the concepts of artificial intelligence, machine learning and deep learning.

Fill in the fields 1-2-3 in the figure below according to the Machine Learning, Artificial Intelligence and Deep Learning options, taking into consideration the scope of the concept.

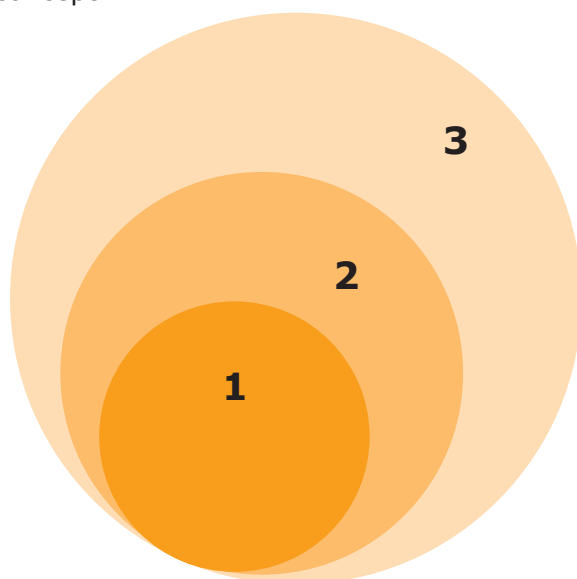

1:

2:

3:

ASSESSMENT AND EVALUATION 2

Read the questions below and tick the correct answer.

1. Which of the following protocols is used to communicate over the Internet?
 A) ADSL B) Ethernet C) MAC D) NIC E) TCP/IP

2. Which of the following cable type is required for high speed data transmission over long distances?
 A) Coaxial cables B) Ethernet cables C) Fiber optic cables
 D) Foiled twisted pair cables E) Twisted pair cables

3. Which of the following is the network element that allows many devices to be included in the local network?
 A) Access Point B) Firewall C) Hub
 D) Router E) Switch

4. Which of the following is the program that enables the use of hardware and the operation of electronic devices?
 A) Browser B) Media editor C) Operating System
 D) Presentation Program E) Word processor

5. What is the software developed for the solution of a problem that users install according to their needs?
 A) Application Software B) Browser C) Operating System
 D) Programming Software E) Word processor

6. Which of the following is the software that gives unlimited usage rights without charge?
 A) Closed source B) Freeware C) Programming
 D) Security E) Trial

7. Which of the following is the name given to the dots which forms the image on the screen?
 A) Contrast B) Gradient C) Pixel D) Saturation E) Resolution

8. Which of the following is not an image file format?
 A) AVI B) GIF C) JPG D) PNG E) PSD

9. Which of the following is the number of pixels seen on the screen at one time?
 A) Number of dots B) Resolution C) LPI
 D) DPI E) Bitmap

10. Which of the following combines two objects?
 A) Merge B) Sum C) Intersect D) Delete E) Trim

UNIT 3

PREPARING
CV AND JOB

APPLICATION
IN A FOREIGN
LANGUAGE

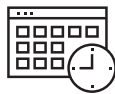

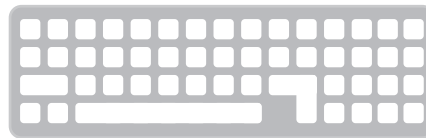
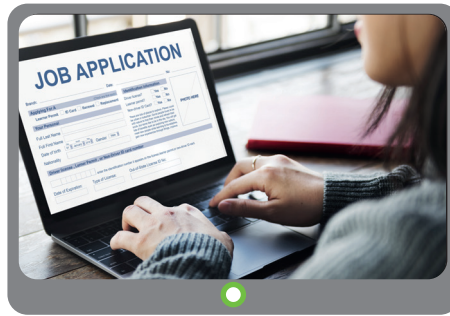
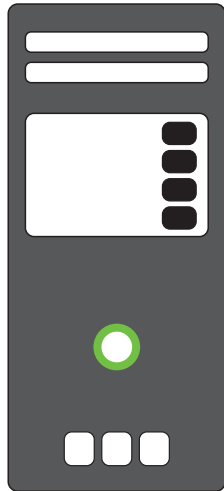

What will you learn?

In this unit you will be able to

- identify the essential information you need to include in your CV
- prepare an effective CV
- send a formal e-mail
- gain the necessary qualifications to apply for a job.

Key Concepts

CV, E-Mail, Skills, Job Application

3. PREPARING CV AND JOB APPLICATION

PRE-READING ACTIVITY

Share your thoughts on the given questions below with your classmates.

1. Discuss why CVs are important for a job or scholarship you are applying for.
2. In what situations might you need a CV?
3. What are the questions that can be asked by the employer in job applications?
Please do a research about these questions.

Although it seems very easy to prepare a CV, it is experienced that it is not easy at all. CVs are a historical record of your skills, qualifications and job experience. On the other hand, it is also the answer to why you should be invited to a job interview or why you should get a scholarship. Therefore, CV preparation is an extremely important and comprehensive process. In this section, you will get significant information about CV preparation and learn important concepts thanks to the activities prepared for you. You will also be able to prepare your Europass CV. In the second part of this chapter, you will be prepared for the situations you may encounter in a job application and a job interview.

3.1. CV (CURRICULUM VITAE)

In its simplest definition, a CV is a summary document containing important information about you. CVs provide personal details, education, job experience and your skills. CVs are prepared for different purposes. Applying for a job or a scholarship are some of these purposes. It is often not recommended to prepare a single CV and use it in all applications. Highlighting your skills which are suitable for the application is extremely important or a powerful CV. A standard CV has the following components:

- Personal information (name, surname, etc.)
- Contact information (address, phone, e-mail, social media handles)
- Education
- Work history and experience
- Skills
- Achievements

Apart from these sections, some optional sections can be added to CVs. Age, marital status, hobbies, references can be given as examples of these sections. You can prepare your own CV by using CV templates both in word processing programs and on websites. Before preparing it, the fields that you need to add to your CV should be reviewed.

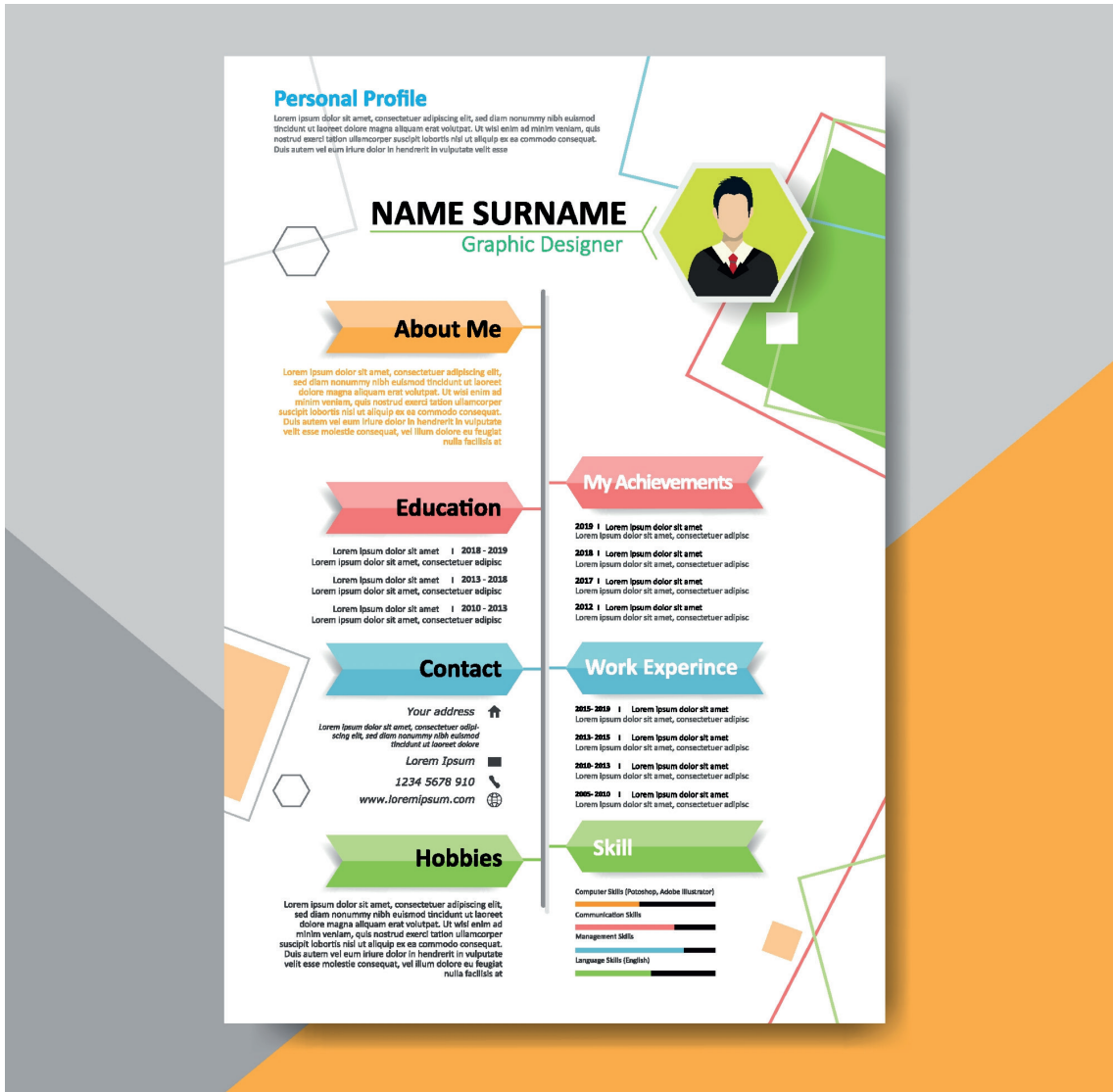

Personal information: This section contains name and surname information. In daily life, your friends or family may call you by different names. You should use your first and last name in your CVs.

Contact information: In this section, you should provide a series of information that will enable the institution you are applying to reach you easily. When providing this information, you should consider the following recommendations:

- Do not forget to include the country code when writing your phone number.
- Make sure your e-mail address is professional. For example, using an email address such as bilisimci06@gmail.com is not recommended. Instead, you should choose an address that includes your name and surname.
- When putting your address information, write the neighbourhood and street names as in Turkish. Do not translate the address into English.

UNIT 3: PREPARING CV AND JOB APPLICATION IN A FOREIGN LANGUAGE

- You can optionally add your social media accounts. It is enough to add your username (handle) and state which platform it is instead of writing the full address. E.g; Twitter: @MeslegimHayatim



Education: In this section, you can give your education information in a chronological order. Along with the education information, your attending and graduating year, grade point average, and the location of your school can also be added.

Work history: Work experiences, if any, are added to this section. It is recommended to include work experiences in chronological order. In addition, you should state the company name, location, dates employed, your job title and responsibilities. In summary, you should gather the whole information in this section.



Vocational Foreign Language

Skills: This section is related to the reason for preparing the CV. For example, if you are applying for the position of Data Science Specialist, adding your skills in this field will make your CV more qualified. It is also important to prove your competencies in this section. For example, the certificates you have received for data science can be added to this section.



<input type="checkbox"/> analysing	<input type="checkbox"/> illustrating	<input type="checkbox"/> piloting
<input type="checkbox"/> briefing	<input type="checkbox"/> implementing	<input type="checkbox"/> planning
<input type="checkbox"/> budgeting	<input type="checkbox"/> improving	<input type="checkbox"/> precision
<input type="checkbox"/> calculating	<input type="checkbox"/> influencing	<input type="checkbox"/> presenting
<input type="checkbox"/> classifying	<input type="checkbox"/> informing	<input type="checkbox"/> prioritising
<input type="checkbox"/> coaching	<input type="checkbox"/> initiating	<input type="checkbox"/> problem-solving
<input type="checkbox"/> collaborating	<input type="checkbox"/> innovating	<input type="checkbox"/> public speaking
<input type="checkbox"/> communicating	<input type="checkbox"/> inspiring	<input type="checkbox"/> relationship building
<input type="checkbox"/> computing	<input type="checkbox"/> installing	<input type="checkbox"/> risk assessment
<input type="checkbox"/> conceptualising	<input type="checkbox"/> interpreting	<input type="checkbox"/> scheduling
<input type="checkbox"/> constructing	<input type="checkbox"/> interviewing	<input type="checkbox"/> simplifying
<input type="checkbox"/> consulting	<input type="checkbox"/> investigating	<input type="checkbox"/> sorting
<input type="checkbox"/> creating	<input type="checkbox"/> judging	<input type="checkbox"/> summarising
<input type="checkbox"/> decision-making	<input type="checkbox"/> launching	<input type="checkbox"/> supervising
<input type="checkbox"/> designing	<input type="checkbox"/> leading	<input type="checkbox"/> teaching
<input type="checkbox"/> disseminating	<input type="checkbox"/> learning quickly	<input type="checkbox"/> team building
<input type="checkbox"/> documenting	<input type="checkbox"/> listening	<input type="checkbox"/> testing
<input type="checkbox"/> empowering	<input type="checkbox"/> making presentations	<input type="checkbox"/> time-management
<input type="checkbox"/> evaluating	<input type="checkbox"/> managing	<input type="checkbox"/> training
<input type="checkbox"/> experimenting	<input type="checkbox"/> managing people	<input type="checkbox"/> using tools
<input type="checkbox"/> explaining	<input type="checkbox"/> marketing	<input type="checkbox"/> versatility
<input type="checkbox"/> facilitating	<input type="checkbox"/> memorising	<input type="checkbox"/> visualising
<input type="checkbox"/> forecasting	<input type="checkbox"/> mentoring	<input type="checkbox"/> winning
<input type="checkbox"/> generating ideas	<input type="checkbox"/> motivating	<input type="checkbox"/> working to deadlines
<input type="checkbox"/> guiding	<input type="checkbox"/> negotiating	<input type="checkbox"/> working under pressure
<input type="checkbox"/> handling conflict	<input type="checkbox"/> networking	<input type="checkbox"/> writing
<input type="checkbox"/> helping	<input type="checkbox"/> painting	

UNIT 3: PREPARING CV AND JOB APPLICATION IN A FOREIGN LANGUAGE

On The Computer	I am good at
Coding	<ul style="list-style-type: none"> Developing desktop application Creating algorithms and flowcharts Developing mobile application Object-oriented programming Mastering multiple programming languages
Networking	<ul style="list-style-type: none"> Interconnecting two computers Designing local area networks Creating a corporate network Strengthening the password of the wireless network Setting up modem settings
Operating	<ul style="list-style-type: none"> Creating a spreadsheet in a word processor Printing from the printer Installing basic computer programmes Preparing a presentation Preparing a simple database
Designing	<ul style="list-style-type: none"> Designing a corporate logo Designing a poster according to the given topic Designing a web site Creating an infographic Designing a book cover

A suggestion: Although photos are not required in CVs, adding them will increase the memorability of your CV.



IT'S YOUR TURN 2

Please add your previous achievements and details in the table below. You can write your scientific, cultural or sports achievements in this field. Your achievements may be at the school, national or international level.



Your achievements



Competition name and year	Subject	Your degree

It has been previously stated that besides the basic components added to the CVs, optional sections can also be added. There is no single truth with CVs. The table below shows other sections that can be added to the CV.

Optional sections to add to CV

Hobbies: Although it is not a required part, sometimes it can be an advantage to add it to CVs. You can add your hobbies such as reading books, going to the theater, riding a bicycle to this section.



Voluntary work: You can add your volunteer work to this section. For example, a study such as vocalizing a book for visually impaired people can be added to this section.

Vocational Foreign Language

Language Skills: In this section, you can give information about languages you speak other than your first language. You can add the language with your level of proficiency, and the results and the certificates of the exams, if any.

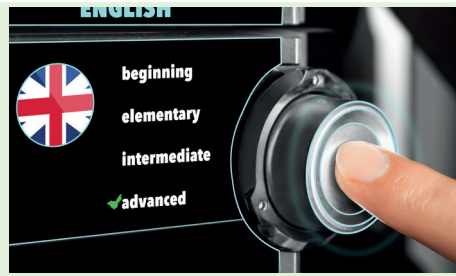

Driver's license: In some jobs, having a driver's license can be an advantage. Class of your driver's license and other information can be given.

References: People who will inform about you for the purpose of your application can also be added to the CVs. Name and surname, job title and contact information of these people should be added.



Other sections: Information such as gender, criminal status, disability, marital status can also be added to CVs.

SOME TIPS FOR AN EFFECTIVE CV

1. Give your message to the person who will review the CV in 30 seconds.
2. Shape your CV in accordance with your application purpose.
3. Highlight your relevant skills and experience.
4. Choose a template suitable for your application.
5. Don't use first person pronouns.
6. Make sure you use bullets.
7. Add impressive keywords to your application.
8. Highlight your achievements.
9. Let CV be your powerful mini-story.
10. Pay strict attention to what visual elements and fonts you use.



IT'S YOUR TURN 3

So far, the components that can be added to the CV have been demonstrated in a practical way. You can now create your own CV.

It has been mentioned before that there are different CV formats. Europass CV was preferred in this book. With the Europass CV, which is widely used throughout Europe, you can make your skills and competences visible. In addition, this format gives you an advantage as it is also used in European Union countries. Now create your CV step by step. You can make a class board with the prepared CVs.

Step 1: Enter <https://europa.eu/europass/en>. Click the "Create CV" button.

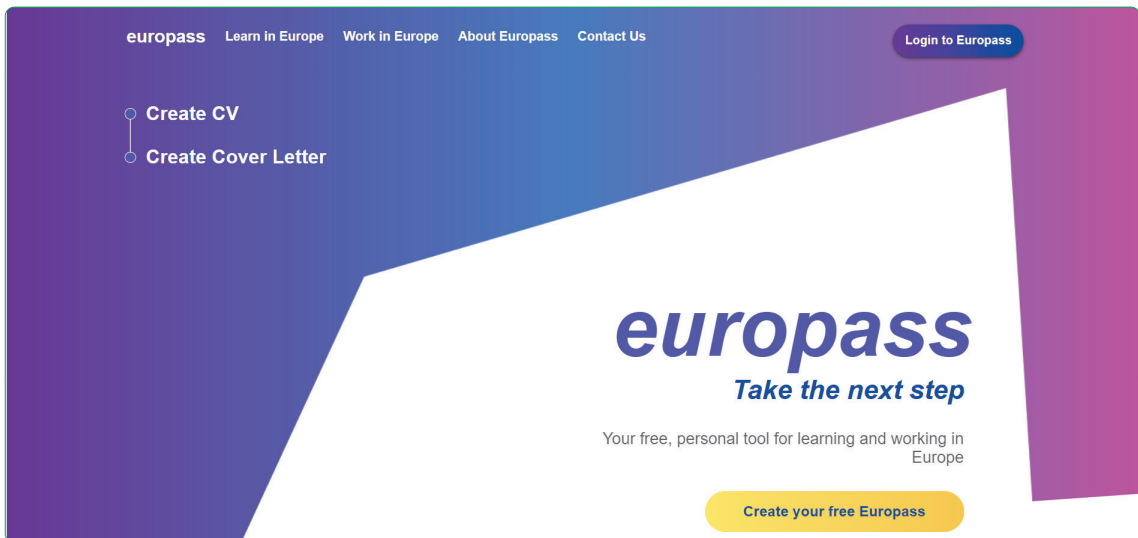

Step 2: Select the "Create Europass Profile" option in the pop-up window (e2).

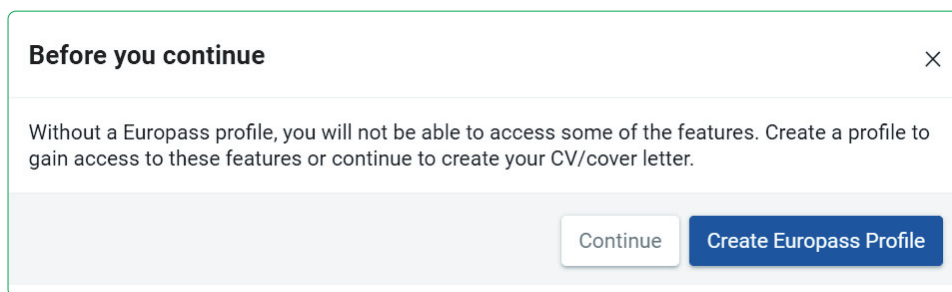

Vocational Foreign Language

Step 3: Register by selecting "Register" on the screen.

Create your Europass ×

To save your information and use all the tools that Europass offers, register now.

Europass is your free set of online tools and information that helps you manage every step of your learning and career.

[Register](#)

Are you already registered? [Login here](#)

or

You may continue as a guest without registering. Be aware that the information you enter will be deleted after 48 hours.

[Continue as a guest](#)

Step 4: After creating an account, log in. The following screen will appear. Here, click the "Upload my Europass CV" button to upload the previously created Europass CVs. If you want to create a new one from scratch, click the "Create my profile" option.

1 Welcome 2 Personal information 3 Work experience 4 Education a

Welcome to Europass

You are about to create your new Europass profile. You will be invited to describe basic information about yourself, your skills and interests.

You decide what to complete - you can 'skip', edit and delete all information - there are no mandatory fields except for your name and email address - this is your personal profile to describe all your life, learning and work experiences.

By registering, you agree to Europass using your profile information in line with the [Europass Privacy Statement](#).

[Upload my Europass CV](#) [Create my profile](#)

UNIT 3: PREPARING CV AND JOB APPLICATION IN A FOREIGN LANGUAGE

Step 5: Fill in the Personal information, work experience, education and training, personal skills fields respectively.

Digital skills

List your digital skills here and group them.

Digital skills

Q Add

HTML Coding Good Coding Skill and Etiquette

Web Programming: HTML, CSS, Javascript (front-end), Java (back-end)

Poster and graphical design E - Commerce collaborative

Social skills (Adaptable and flexible; sociable; team work; work ethic)

Problems solving and decision making

Group your skills

Customise your skills and group them in categories.

Exit < Previous

Step 6: After filling in all the information, the following screen will appear. You can add photos on this screen. You can also update your information using the edit button. You can share the link of the CV you have prepared by clicking the **Share button**.

Add profile in a new language



Zeynep Buse Aydemir

My personal information

Personal information

Date of birth: **29/10/2004**

Gender: **Female**

Nationality: **Turkish**

Contact details

zeynepbuseaydemir@gmail.com

+90 1234567

Hacı Bayram Mh. Çankırı Cd. No 41 Address

06050 Ankara, Turkey

Work experience

Web developer

ABC Web Design

01/09/2020 – 30/06/2021 | Ankara, Turkey

- Creating website layout
- Creating user interfaces by using standard HTML/CSS practices
- Integrating data from various back-end services and databases

Add work experience

Vocational Foreign Language

Step 7: Tick the “**Select entire profile**” option on the screen that appears after pressing the **Share** button.

Select

Choose the parts of your profile you wish to share by clicking on the checkboxes placed next to each section.

Select entire profile

Select personal information

Zeynep Buse Aydemir

Personal information

Date of birth: 2004 10 29

Gender: Female

Nationality:

Turkish

Contact details

zeynepbuseaydemir@gmail.com

+90 1234567

Hacı Bayram Mh. Çankırı Cd. No 41 Address

06050 Ankara, Turkey

Select work experiences

Work experience

Web developer

× Exit

Next >

Step 8: Check your CV.

Review

Review your profile before sharing it. If you wish to make changes, click on the 'Previous' button at the bottom of the page.

Zeynep Buse Aydemir

Date of birth: 29/10/2004 | Gender: Female | Nationality: Turkish

Mobile: (+90) 1234567

Email address: zeynepbuseaydemir@gmail.com

Other: 06050 Ankara, Turkey

WORK EXPERIENCE

Web developer

UNIT 3: PREPARING CV AND JOB APPLICATION IN A FOREIGN LANGUAGE

Step 9: Decide by when your CV will be shared. You can get the sharing link by clicking the “Generate link” button. You can also save your CV as a pdf.

Select Review Share

i You are about to share the link to your personal Europass profile. By sharing this link you consent to sharing your information with a third-party outside the Europass platform. Please be aware that some recipients, particularly if they are located outside the EU, may not follow data protection rules and procedures. Always ensure you know the identity of anyone you share your information with. Select an expiry date for the link. Then copy the link to share your profile. You can manage this link in your Activity Feed.

Share profile

Select a timeframe and copy the link to share your profile

Valid until: *

20 1 2022

Copy the link to share your file(s)

<https://europa.eu/europass/eportfolio/api/eprofile/shared-profile/6ft> **COPY** Generate link

× Exit < Previous Finish

Step 10: Select My Europass from the dropdown menu in the image below.

europass European Union Hello Zeynep Buse Aydemir EN

Learn in Europe Work in Europe Find a job Find a course

Me My Library My Skills My Interests

My Europass

My Profile

Settings

Activity Feed

Help

Logout

that you can create professional CVs based on your Europass profile? [Create your CV now](#) or [watch the tutorial video](#) to see how." × Exit

Add profile in a new language Share Settings Date format

Zeynep Buse Aydemir

English Edit

My personal information ^

Personal Information

Date of birth: 29/10/2004

Gender: Female

Edit

Vocational Foreign Language

Step 11: Click **“Create a CV”** on the left side of the screen that appears.

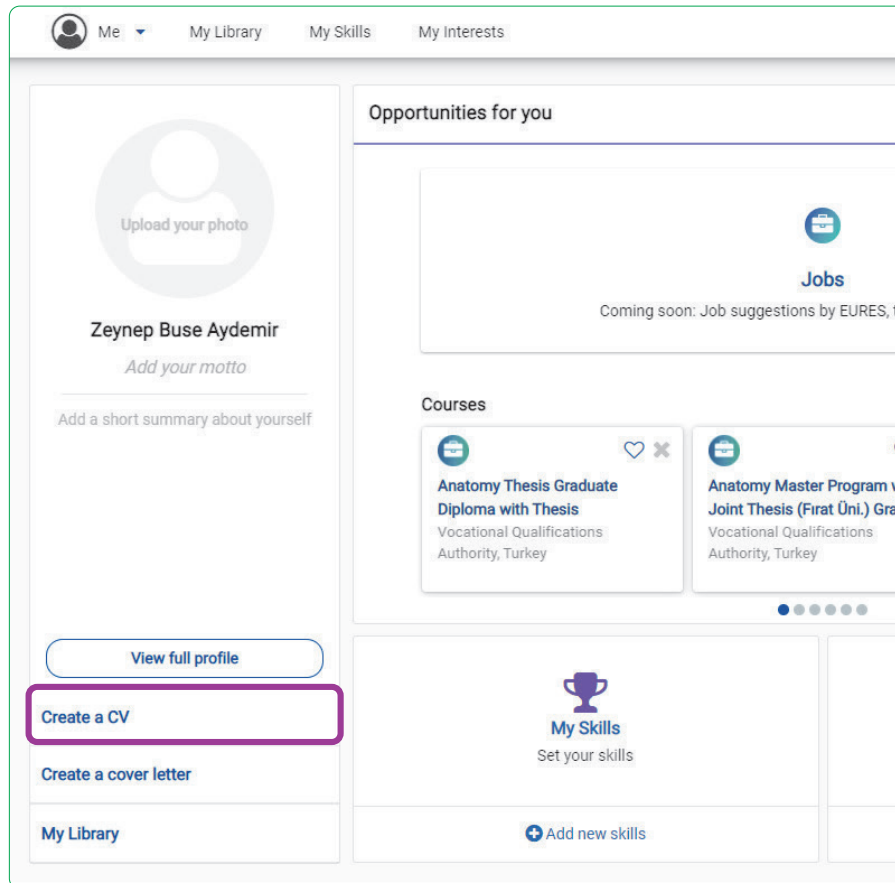

Step 12: Click **“Start from your profile”** on the page that opens and use the information you entered previously.

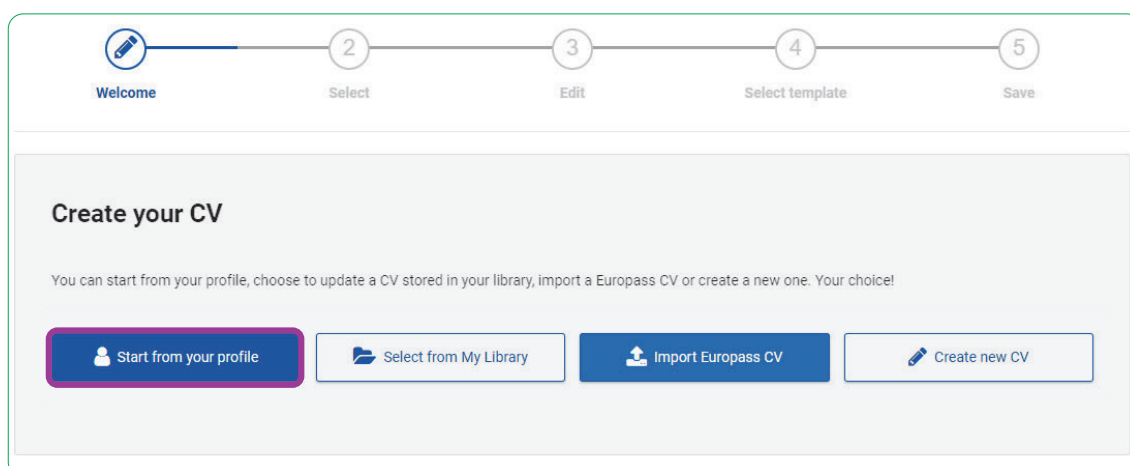

UNIT 3: PREPARING CV AND JOB APPLICATION IN A FOREIGN LANGUAGE

Step 13: On the page that opens, tick **"Select entire profile"** as you did before.

The screenshot shows a progress bar at the top with five steps: 1. Welcome (checked), 2. Select (active), 3. Edit, 4. Select template, and 5. Save. Below the progress bar, the 'Select' section is titled 'Select your entire profile or parts of it by clicking on the checkboxes placed next to each section below.' There are two main sections: 'Select personal information' and 'Select work experiences'. The 'Select personal information' section is expanded, showing a profile picture placeholder and the name 'Zeynep Buse Aydemir'. Under 'Personal information', there are checkboxes for 'Date of birth: 29/10/2004', 'Gender: Female', and 'Nationality: Turkish'. Under 'Contact details', there are checkboxes for 'zeynepbuseaydemir@gmail.com', '+90 1234567', and '06050 Ankara, Turkey'. The 'Select work experiences' section is partially visible, showing a checkbox for 'Web developer'. At the bottom left, there is an 'Exit' button, and at the bottom right, there is a 'Next' button.

Step 14: On the next page, you are asked whether you want to make changes to your information. Click the **"No, thanks"** button to pass without making any changes.

The screenshot shows a progress bar at the top with five steps: 1. Welcome (checked), 2. Select (checked), 3. Edit (active), 4. Select template, and 5. Save. Below the progress bar, the 'Edit' section is titled 'Edit' and asks 'Do you want to edit the information before creating your CV?'. There are two buttons: 'No, thanks' (highlighted with a red box) and 'Yes, I do'.

Vocational Foreign Language

Step 15: Go ahead this step by choosing a template for your CV.

The screenshot shows the 'Select template' step in a five-step process. The steps are: Welcome, Select, Edit, Select template (current), and Save. The main content area displays a preview of a CV template for 'Zeynep Buse Aydemir'. The CV includes the following information:

- PERSONAL INFORMATION:** Zeynep Buse Aydemir, DATE OF BIRTH: 29/10/2004
- CONTACT:** Nationality: Turkish, Gender: Female, 06050 Ankara, Turkey, zeynepbuseaydemir@gmail.com, (+90) 1234567
- WORK EXPERIENCE:** 01/09/2020 - 30/06/2021 - Ankara, Turkey. Job: Web developer at ABC Web Design. Skills: Creating website layout, Creating user interfaces by using standard HTML/CSS practices, Integrating data from various back-end services and databases.
- EDUCATION AND TRAINING:** 2017 - 2021 - Ankara, Turkey. Vocational High School Graduate-Information Technologies at Atatürk Mesleki ve Teknik Anadolu Lisesi (https://atamml.meb.k12.tr/). 2020 - 2021 - Ankara, Turkey. Web Development with HTML5 at BTK Akademi. 2019 - 2020 - Ankara, Turkey. Introduction to E-Commerce at BTK Akademi.
- LANGUAGE SKILLS:** MOTHER TONGUE(S): Turkish, OTHER LANGUAGE(S): English

Below the preview, there are options to 'Add Europass logo' (Every page or First page only) and an 'Exit' button. Navigation buttons for 'Previous' and 'Next' are also visible.

Step 16: In the last step, give your CV a name and click the **"Download"** button to save your CV to your computer.

The screenshot shows the 'Select format, save and share' step in a five-step process. The steps are: Welcome, Select, Edit, Select template, and Save (current). The main content area prompts the user to 'Choose a name for your CV'. The name 'ZeynepBuse' is entered in the 'Name' field. The 'Select format' section shows 'PDF' selected. Below this, there are three buttons: 'Download' (highlighted with a red box), 'Save in My Europass Library', and 'Publish on EURES'.

IT'S YOUR TURN 4

Here, you are expected to create your own Europass CV. Please make sure to complete it properly in Europass template and save it in the appropriate format. After creating them, display your CVs on your class board.

Assessment: Your work will be evaluated according to the criteria in the checklist below. Take these criteria into the consideration while doing your work.

CHECK LIST

Please put (X) sign under the YES section for the criteria you observed in the student from the criteria listed below, and NO for the criteria you didn't observe.

Criteria	Yes	No
1. Personal Information (name, surname, etc) was added to the CV.		
2. Contact information (telephone, e-mail etc) was added to the CV.		
3. Education information was added to the CV.		
4. Work experience was added to the CV.		
5. Achievements were added to the CV.		
6. Skills were added to the CV.		
7. CV was properly completed using the template.		

3.2. JOB APPLICATION

In the first part, you learned how to prepare an effective CV. It can be said that the CV preparation section is, in a sense, preparation for the job application. In this section, you will learn about the stages of job application. In general, a job application consists of the following steps:

- CV preparation and Cover letter writing
- Job application
- Interview
- Job offer

3.2.1. CV Preparation and Cover Letter Writing

CV preparation is explained in the first topic of this chapter. It is also important to write a cover letter and CV together. The cover letter explains why your skills and experiences are suitable for the position you are applying for. While it is required in

Vocational Foreign Language

some applications, it may be optional in some applications. Cover letter should be prepared according to the job to be applied for. In the cover letter, you should refer to key examples in your CV and explain why these examples are important to the job position you are applying for.



IT'S YOUR TURN 5

Do an internet research on how to write an effective cover letter. Prepare a cover letter using the Europass website by choosing one of the positions listed below. Share your cover letter with your teacher and classmates and get their feedback.

1. Web Developer
2. Network Technician
3. Data Scientist
4. Cyber Security Specialist
5. Software Developer

3.2.2. Job Applications

There are some websites where you can look for a job, as well as institutions where you can apply for a job. You can apply for jobs online, via email, or in person. Whichever way you apply, you must follow the job application guidelines of the institution you are applying to. For online applications, the employer's application form is filled. Application forms may differ. In-person applications, you are expected to prepare and submit the requested documents. Some institutions may also want applications to be sent by an e-mail. Not only in a job application, but also in business

life, it is frequently necessary to send an e-mail. That's why creating an e-mail in a formal language can be a good step. Generally, emails consist of 4 parts: Subject, Greeting, Text, Closing.

Subject: Write the reason for sending the e-mail briefly here. It is a common mistake to write the text of the email in this section and leave the text field blank. For example, you should write a short subject that describes your email, such as Requesting a meeting.

Greeting: In this section, you address the person you are sending the email. For example, you can start as Dear Director Ayyıldız, Dear Professor Arslan. If you're writing to a group, start with something like Dear Sales Team. If you have no idea about the person or group you are addressing, Dear Sir/Madam, which gives the meaning to the person concerned, is a good option.

Note: The phrase To Whom It May Concern also shows the person concerned. It is generally used in reference letters.

Text: It is the area where you will express yourself in your e-mail. It is recommended not to be too long. When the e mail consists of 2 paragraphs of 3-4 sentences, it can be read easily without being distracted by the recruiter. Make a maximum of 1-2 requests in this section. Avoid complaining about an issue.

Closing: This is the section where you end your email and convey your best wishes to the email recipient. You can end your email with a phrase like best regards. Just below, you can write your name and surname, your job if you wish and complete the e-mail.

Before sending your email, read it again from the beginning and send it!

An example email:

Dear Mrs. Richards,

I hope you are fine. I focused on web development during my senior high school internship and I am interested in your job position. I am writing you this email for the web developer position on your company's website. I would like to receive information from you about the requirements for this position. Thank you in advance for your reply.

Kind regards,
Zeynep Buse Aydemir

SOME TIPS THAT WILL WORK FOR YOU WHEN WRITING AN EMAIL.

1. Your email should be clear and brief.
2. Use active sentences instead of passive sentences.
3. Avoid strong words such as must, should, demand, require, and necessity.
4. Do not use exclamation points.
5. Make sure your subject line is short and clear.
6. Be brief introducing yourself in your first email to someone.
7. Use a professional email address.
8. Keep your tone polite.
9. Avoid expressions of complaints and accusations.
10. Make sure you review the before sending it.



IT'S YOUR TURN 5

Write an e-mail according to the scenario below.

You have applied for a job. You haven't gotten a respond back yet on the specified date. Another job application has gone successfully and your approval is being awaited to start the job. But your priority is the first job and you will be happy if the recruiter gets back to you at once, besides uncertainty will disappear. Because of the difficult situation you are in, write a polite e-mail. You can randomly create the names of people and institutions.

Assessment: Your work will be evaluated according to the criteria in the checklist below. Take these criteria into the consideration while doing your work.

CHECK LIST

Please put (X) sign under the YES section for the criteria you observed in the student from the criteria listed below, and NO for the criteria you didn't observe.

Criteria	Yes	No
1. The e-mail was written in accordance with the scenario.		
2. The e-mail was written in a formal language.		
3. The greeting was done appropriately.		
4. The subject of the e-mail was written in accordance with the rules.		
5. Sign-offs were included at the end of the text.		
6. The message was delivered concisely and clearly.		
7. Active sentences were used in the e-mail.		

3.2.3. Interview (Job Interview)

After applying for a job, the employer decides whether to invite you for an interview by evaluating your CV and cover letter, if any. It should not be forgotten that there are many applications for a job and these are scanned quickly. Therefore, it is important to create an effective CV or write an effective cover letter. After being called for an interview, a new process begins for the candidate. You should take the following factors into the consideration.



- Confirm the interview time and date in advance, in written, if possible. While deciding the interview day, make sure you will have some time to prepare in advance.
- Before the interview, research potential interviewers and get some information what they care about. Take a look at the organization’s mission, vision and work. Also, view the job description for the job you’re applying for. Research frequently asked questions in interviews and prepare your possible answers. Create an interview story.
- Dress appropriately depending on the job you are applying for. However, you should not let your clothes draw too much attention to yourself. And don’t forget to mute your mobile phone.
- Be present on the interview day before the interview time. Have your notebook or tablet/ laptop with you. It is not recommended to take notes with a mobile phone. You may also have some questions to the employer. It is important for you to take notes of your questions in advance.

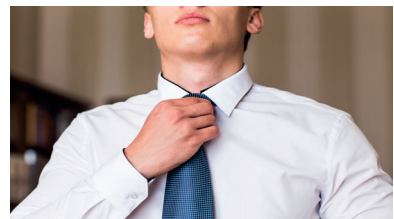

Vocational Foreign Language

- Bring an up-to-date CV with you to the interview. Review your CV before the interview. Make sure all the information on the CV is verifiable. The employer may ask you for details about some parts of your CV.



- When the interviewer arrives, greet him/her and briefly introduce yourself.



- Do not try to direct the interview. Employer is the one who should guide the process. Be a good listener and listen carefully to the employer's questions.



- While listening to the employer, some questions may come to your mind. Take note of your questions. Without interrupting his speech and after answering the questions, you can ask your questions.



- You may have a story or flow in your head. During the interview, answer the interviewer's questions rather than what you plan to say in advance.

- Be sincere while answering questions. Avoid accusatory statements, especially if you receive questions about your previous job. The employer may conduct a stress interview. In this case, keep your calm.

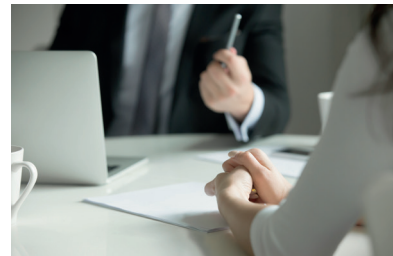

- When talking about your career, mention your failures and areas that could be improved as well. You can use the STAR method while describing what you did in this section. Explain the situation you were in, what was expected of you, the action you took and the results respectively. With this method, you can summarize your experience.

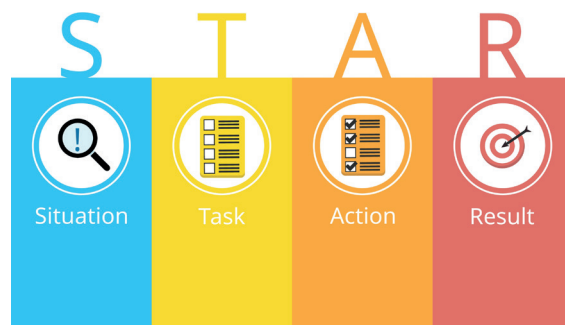

UNIT 3: PREPARING CV AND JOB APPLICATION IN A FOREIGN LANGUAGE

- You can find frequently asked interview questions on various web sites. Tell us about yourself? How do people describe you? Why should I hire you? Classic questions can be asked. Giving the answers desired by the interviewer is important for getting positive results. For example, talk about what you can add to the organization with your experience and skills.
- At the end of the interview, the employer asks if you have any questions or not. In the meantime, you can ask questions that you have noted before.

IT'S YOUR TURN 6

In this activity, you are asked to do an internet research and list the frequently asked questions in interviews. And then, divide into groups of four and prepare a role play. Choose two of you as an employer and and an applicant. Make them interview each other and choose the others as observers to share their opinions at the end of the interview.



3.2.4. Job offer

The interview may require more than one interviews. After the interview, the employer can research about you and get information from your references. It concludes the whole process and decides whether to offer you a job or not. Even if the process ends up with a negative result, the interview will give you an experience and will make you feel more comfortable for the next interviews. When a job offer is made, both parts conclude the process by stating their mutual demands.



IT'S YOUR TURN 7

Here, you are asked to prepare a material that will summarize the steps to be considered in a job application by revising the entire job application section. The material should be a learning output such as a blog or poster.

Assessment: Your work will be evaluated according to the criteria in the checklist below. Take these criteria into the consideration while doing your work.

CHECK LIST

Please put (X) sign under the YES section for the criteria you observed in the student from the criteria listed below, and NO for the criteria you didn't observe.

Criteria	Yes	No
1. It was made sure that the content of the material reflects the subject.		
2. It was made sure that the material summarizes the job application.		
3. The learning output (blog, poster etc.) was chosen according to the instruction.		

ASSESSMENT AND EVALUATION 3

Answer the following questions.

1. Which of the following skills are hard skills?

- A) Collaboration B) Communication C) Leadership
D) Machine learning E) Time management

2. Which of the following is one of the optional parts in CVs?

- B) Contact information B) Education information
C) Hobbies D) Skills and achievements
E) Work history

3. Which one is wrong for CVs?

- A) CVs are documents that are not updated.
B) CVs must be specific to the application.
C) Skills and experiences should be highlighted in CVs.
D) CVs must contain contact information.
E) CVs may have different structures.

4. Which of the following is not one of the email sections?

- A) Closing B) Cover letter C) Greeting D) Subject E)Text

5. What is the software developed for the solution of a problem that users install according to their needs?

- A) You should introduce yourself by greeting the interviewer.
B) Be a good listener and not interrupt the other person.
C) You should give short and clear answers to the questions.
D) You must be sincere and make the other one feel it.
E) You should write down your questions on your mobile phone during the interview.

6. Which one you don't need to do in the pre-interview preparation?

- A) Getting information by contacting the people working in that institution
B) Researching the institution you are applying to
C) Checking that your CV is up-to-date
D) Researching and preparing for possible questions
E) Reviewing the job description

ANSWER KEYS(IT'S YOUR TURN)

UNIT 1: HARDWARE CONCEPTS IN A FOREIGN LANGUAGE

It's Your Turn 1: Hardware

- A) 1- D
2- C
3- B
4- A
- B) 1- T
2- F
3- T
4- F
- C) 1- Information Technology
2- Hardware
3- Computer Case
4- Power Cable
5- CPU Central Processing Unit

Puzzle

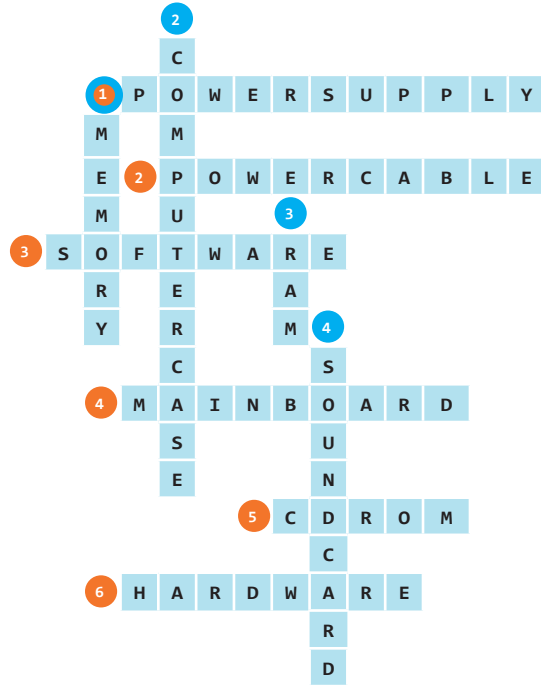

It's Your Turn 2: Mainboard

- A) 1- ATX Power Connector
2- CMOS Backup Battery
3- CPU Fan & Heatsink Mounting Points
4- CPU Socket
5- Connectors for Integrated Peripherals
- B) 1- T
2- F
3- T
4- T
- C) 1- Data Bus
2- Slot
3- Interface
4- Bandwith
5- Capacity

Puzzle

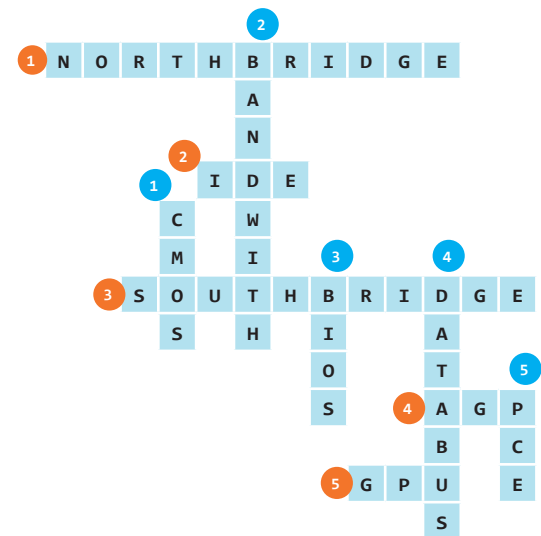

It's Your Turn 3: CPU

- A) 1- C
2- A
3- B
4- D
- B) 1- T
2- T
3- F
4- F
5- T
- C) 1- Brain of Computer
2- Arithmetic Logic Unit
3- Thermal Paste
4- Heat pipe cooling
5- Machine Language

Puzzle

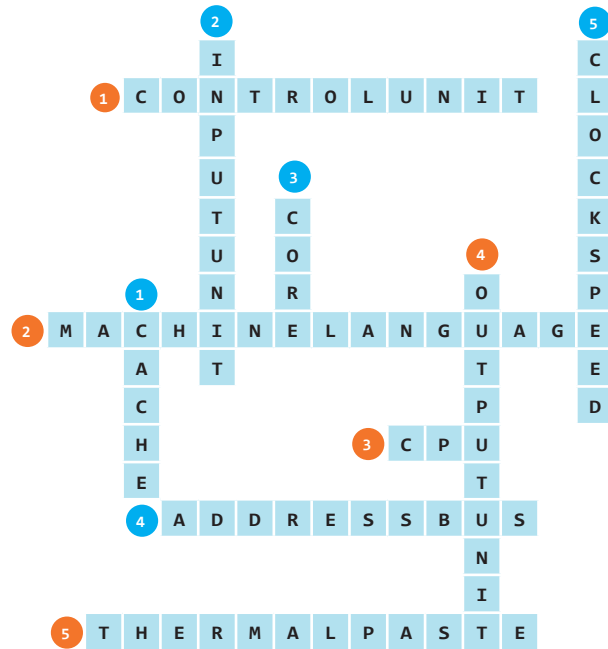

It's Your Turn 4: Memory

- A) 1- Memory Chip
2- Socket
3- Edge Connector
4- Notches for Socket (Handles)
- B) 1- F
2- T
3- T
4- F
5- T
- C) 1- Temporary Storage
2- Computer Science
3- Frequency
4- Switched off
5- Mounted

Puzzle

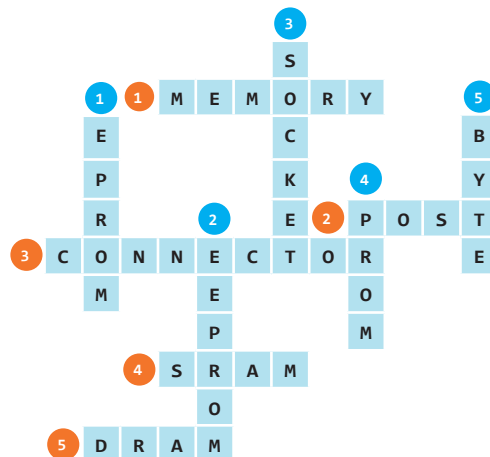

It's Your Turn 5: Graphics Card(Display Adapter)

- A) 1- Graphics Card
2- Digital Signal
3- Digital - Analogue Converter
4- Analogue Signal
5- Monitor
- B) 1- T
2- F
3- F
4- T
5- F
- C) 1- Image
2- Slot Clips
3- screwdriver
4- Unplug
5- pull

It's Your Turn 6: Disks

- A) 1- HDD Case
2- Platter
3- Spindle (Disk Driving Motor)
4- Actuator Arm
5- Actuator
- B) 1- F
2- T
3- F
4- T
5- T
- C) 1- RPM (Rotate Per Minute)
2- plates
3- performance of the hard disk drive
4- rotation of the motor
5- read-write head

It's Your Turn 7: Optical Drives

- A) 1- C
2- B
3- D
4- A
- B) 1- T
2- T
3- F
4- T
5- T
- C) 1- Double layer
2- High resolution
3- Optical drives
4- Large
5- Red light

It's Your Turn 8: Keyboard

- A) 1- Enter Key
2- Typewriter Keyboard
3- Movement Keys
4- Numeric Keypad
5- Function Keys
- B) 1- T
2- T
3- F
4- T
5- T
- C) 1- Circuit Board
2- Conductive Paths
3- Laptop
4- Connection Technologies
5- Symbol



It's Your Turn 9: Mouse

- A) 1- Right-left Button
2- optical sensor
3- scroll Wheel
4- Capacitors
5- Resistors
6- Wires Out
- B) 1- T
2- T
3- F
4- T
5- F
- C) 1- dpi (dots per linear inch)
2- Scroll Wheel
3- light source
4- dots
5- resolution

Puzzle

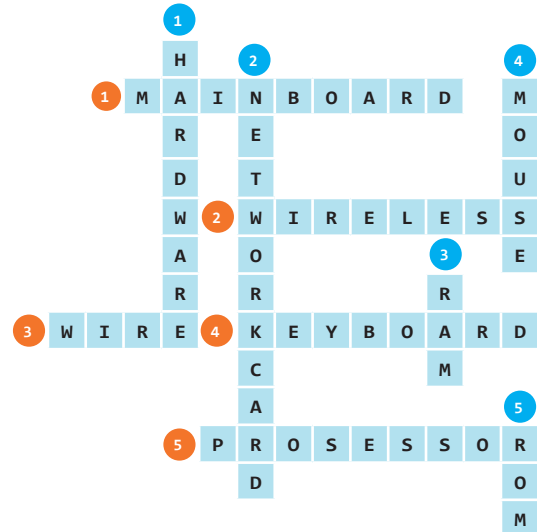
**It's Your Turn 10: Monitors**

- A) 1- Rear Plate Glass
2- One Plasma Pixel
3- Phosphor coating in plasma cells
4- Front Plate Glass
5- Dielectric Layer
- B) 1- T
2- F
3- T
4- F
5- T
- C) 1- Layer
2- UV radiation
3- Light Source
4- cone
5- Low contrast

It's Your Turn 11: Printers

- A) 1- Paper Tray
2- Laser Scanning Unit
3- Photoreceptor DRUM
4- Toner Hopper
5- Developer Roles
- B) 1- T
2- T
3- F
4- F
5- T
- C) 1- Working System
2- Drum
3- Graphic Model
4- Toner Powder
5- Printhead

It's Your Turn 3: Network Equipment

- A) 1- 2
 2- 3
 3- 1
 4- 5
 5- 4
- B) 1- F
 2- T
 3- F
 4- T
 5- F
- C) 1- Network Interface Card(NIC)
 2- Router
 3- UDP(User Datagram Protocol)
 4- Media Access Control(MAC)
 5- Server

Puzzle



It's Your Turn 4: Software

- A) 1- A
 2- B
 3- E
 4- C
 5- D
- B) 1- T
 2- F
 3- F
 4- T
 5- T
- C) 1- Freeware
 2- Operating System
 3- Hardware
 4- Security Software
 5- Application software

Puzzle

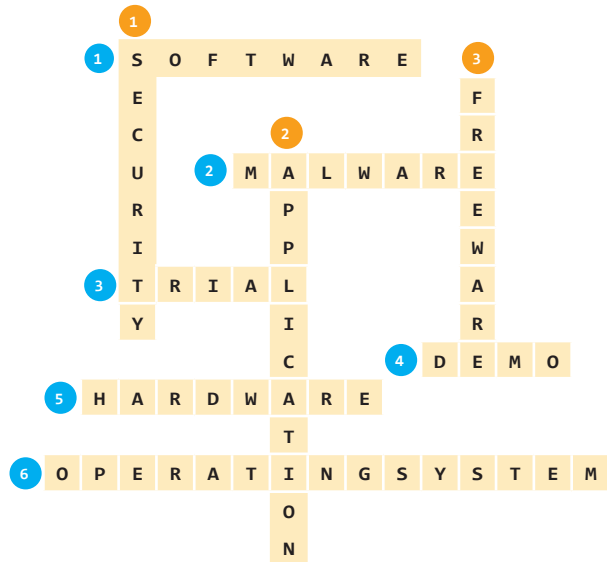

Vocational Foreign Language

It's Your Turn 5: Web, Graphics And Animation

- A) 1- D
2- E
3- A
4- C
5- B
- B) 1- T
2- F
3- F
4- T
5- F
- C) 1- Align
2- Source
3- Hyperlink
4- Bullets and Numbering
5- Merge

Puzzle

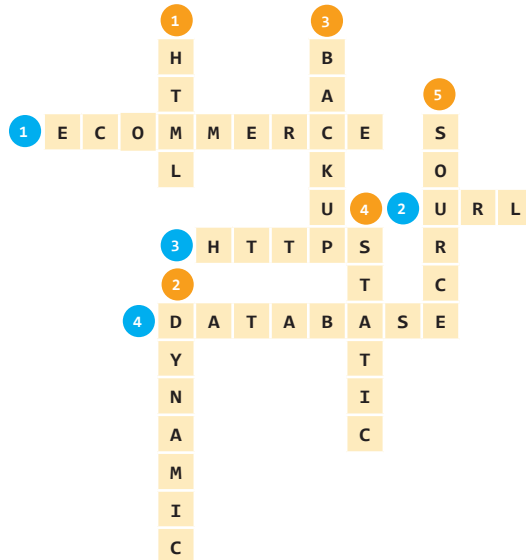

It's Your Turn 6: Website Domain Extensions

- A) 1- mil
2- com
3- edu
4- gov
5- info
- B) 1- T
2- F
3- F
4- T
5- F
- C) 1- Domain
2- edu
3- ftp
4- http
5- Hosting

It's Your Turn 7: Graphics And Animation

- A) 1- E
2- C
3- D
4- B
5- A

- B) 1- T
2- F
3- T
4- T
5- F

- C) 1- Grid
2- Gradient
3- Saturation
4- Soft at the edges
5- Brightness

Puzzle

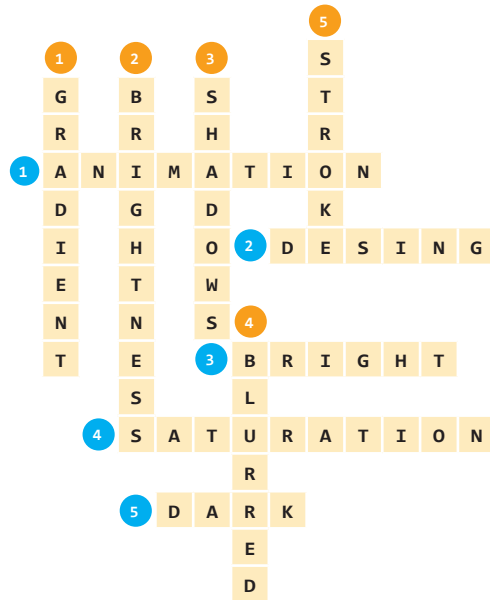

It's Your Turn 8: Image Processing

- A) 1- B
2- A
3- E
4- C
5- D

- B) 1- T
2- T
3- F
4- F
5- F

- C) 1- width
2- density
3- mixture
4- clear
5- dot pitch

Puzzle

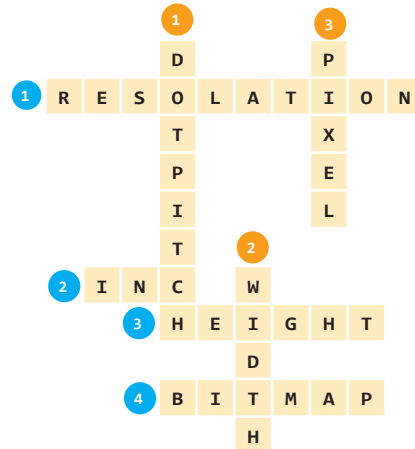

It's Your Turn 9: Image Formats

- A) 1- C
2- E
3- B
4- D
5- A
- B) 1- F
2- T
3- F
4- F
5- T
- C) 1- jpg
2- png
3- tiff
4- pdf
5- bmp
-

It's Your Turn 10: Basic Programming Concepts

- A) 1- E
2- D
3- B
4- C
5- A
- B) 1- T
2- F
3- T
4- T
5- F
- C) 1- comment line
2- algorithm
3- code editor
4- syntax
5- compiler

Puzzle

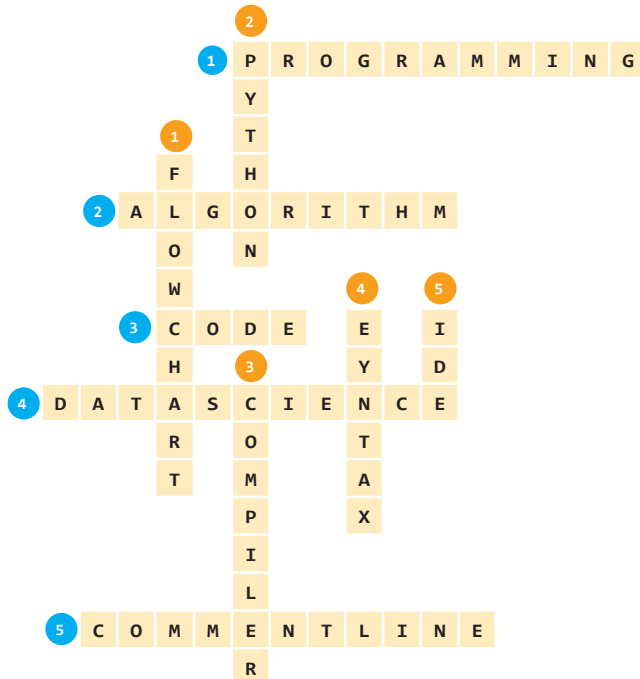

ANSWER KEYS(ASSESSMENT AND EVALUATION)

ASSESSMENT AND EVALUATION 1

- 1- B
 - 2- E
 - 3- D
 - 4- B
 - 5- C
 - 6- E
-
-

ASSESSMENT AND EVALUATION 2

- 1- E
 - 2- C
 - 3- E
 - 4- C
 - 5- A
 - 6- B
 - 7- C
 - 8- A
 - 9- B
 - 10- A
-
-

ASSESSMENT AND EVALUATION 3

- 1- D
- 2- C
- 3- A
- 4- B
- 5- E
- 6- A

REFERENCES

Information Technologies Field The Curriculum Framework

Doyle, A. (2019). *A Step-by-Step Guide to the Job Application Process*. Erişim adresi: <https://www.thebalancecareers.com/job-application-process-2061600>

Innes, J. (2016). *The CV Book: How to avoid the most common mistakes and write a winning CV*. Pearson UK.

McGee, P. (2014). *How to Write a CV that Really Works: A Concise, Clear and Comprehensive Guide to Writing an Effective CV*. Hachette UK.

Mills, C. (2009). *You're Hired! CV*. Crimson Publishing.

VISUAL BIBLIOGRAPHY



<http://kitap.eba.gov.tr/karekod/Kaynak.php?KOD=2422>